

Harness Structural test Report - NfL

Inspection certificate number: **PH_374.2022**

Manufacturer data:

Manufacturer name: **Woody Valley srl**
 Representative: **Simone Caldana**
 Street: **Via Linz 23**
 Post code place: **38121 Trento**
 Country: **Italy**

Sample data:

Name: **MK1 Pro**
 Type: **ABS**
 Size: **M**
 Serial number: **107 0115 002P**
 Impact pad type: ⁽¹⁾ **Foam**
 Clip-in weight [kg]: **120**
 Integrated container: **Yes**
 Date of test: **09.03.2022**

Atmosphere AGL:

[C°]	21
RH [%]	27
[hPa]	1012

Summary of Structural test

Test id	- Ref.	Setup	Req. Load [g]	Req. Load [N]	Min. duration [s]	Result
02	V 5.3.2.1	Default flying position	6	7200	10	POSITIVE
03	V 5.3.2.2	Default flying position	15	18000	5	POSITIVE
04	V 5.3.2.3	Asymmetric, one riser	6	7200	10	POSITIVE
07	V 5.3.2.6	Asymmetric, negative	4.5	5400	10	POSITIVE
09	V 5.3.2.4	Rescue attachments	15	18000	5	POSITIVE
13	V 5.3.2.7	Flying position before landing	15	18000	5	POSITIVE
14	5.3.2.5	Towing	5	6000	10	n/a

Rescue deployment test

Test id	- NfL 2-565-20	Setup	Min load [N]	Max. load [N]	Measured [N]	Result
RRDT	V 6.1.5	Default flying position	20	70	49.67	POSITIVE

Rescue Deployment Handle strength test

Test id	- EN 12491	Setup	Req. Load [N]	Min. duration [s]	Breaking strength [N]	Result
RRST	V 5.3.2	Two end points of handle	700	10	1126.47	POSITIVE

Rescue deployment test with integrated container for rescue system

Test id	- NfL 2-565-20	Setup	Result
RDIC	4.3.2-4.3.6	Release of the container at maximum volume	n/a

Manufacturer	Instrument	Type no	S/N	Validity
HBM	Load Sensor GE01	1-S9M/50KN-1	31314643	04.09.2023
Burster / MTS	Load sensor 10kN SL2	8431-6010-N000S000	593507	21.04.2026
JDC elec	Geos n°11 Skywatch	Geos n°11	Unit11	18.06.2025

Air Turquoise SA, having thoroughly assessed the sample mentioned above, declares it was found conform with
 Airworthiness Requirements **NfL 2-565-20 - EN12491:2015 5.3.2**

The validation of this test report is given by the signature of the test manager on the Inspection Certificate no 94.20

⁽¹⁾ If Impact pad available, see test report no. 94.22 and inspection certificate no. 94.20

Calculated values in tests reports include the value minus the uncertainty (on safe side) / The uncertainty stated is the expanded uncertainty obtained by multiplying the standard uncertainty by the coverage factor $k = 2$. The value of the measurand lies within the assigned range of values with a probability of 95%.

This declaration must not be reproduced in part without the written permission of AIR TURQUOISE SA.

Inspection certificate number: **PH_374.2022**

model: **MK1 Pro**

Harness Structural test

Test ID 02

Standard	NfL 2-565-20
Reference	5.3.2.1
Test setup	Default flying position
Attachment points	Both main riser attachment (3,4)
Anchor points	Dummy (B1, B2)
Required load [g]	6
Required load [N]	7200
Minimum test duration [s]	10
Result	
Test duration [s]	17.1
Any signs of structural failure	No
Test results	POSITIVE

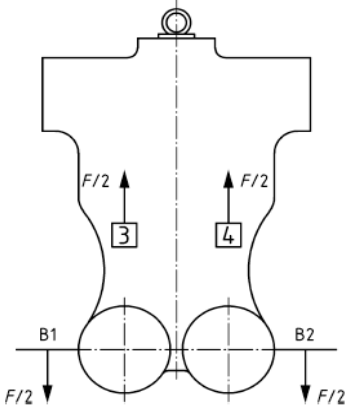
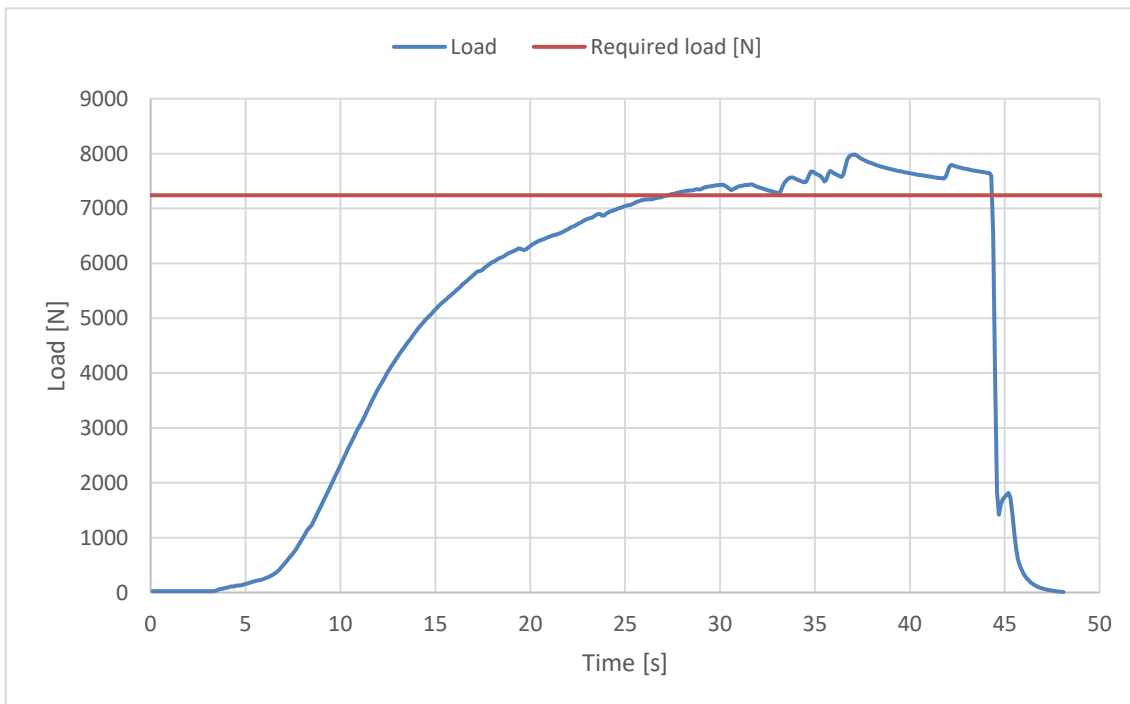
The validation of this test report is given by the signature of the test manager on the Inspection Certificate no 94.20

Inspection certificate number: **PH_374.2022**

model: **MK1 Pro**

Harness Structural test

Test ID 03

Standard **NfL 2-565-20**
 Reference **5.3.2.2**
 Test setup **Default flying position**
 Attachment points **Both main riser attachment (3,4)**
 Anchor points **Dummy (B1, B2)**

Required load [g] **15**
 Required load [N] **18000**
 Minimum test duration [s] **5**

Result

Test duration [s] **7.1**
 Any signs of structural failure **No**
 Test results **POSITIVE**

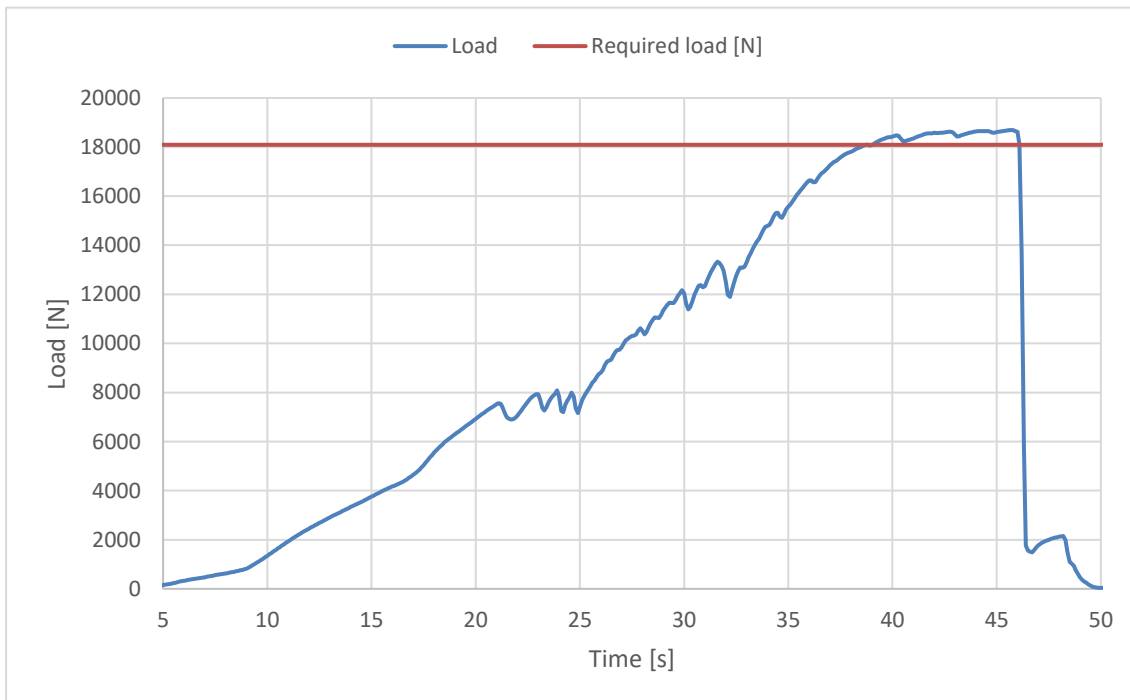
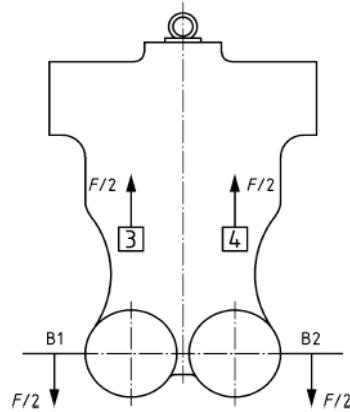

The validation of this test report is given by the signature of the test manager on the Inspection Certificate no 94.20

Inspection certificate number: **PH_374.2022**

model: **MK1 Pro**

Harness Structural test

Test ID 04

Standard	NfL 2-565-20
Reference	5.3.2.3
Test setup	Asymmetric, one riser
Attachment points	One main riser attachment (3)
Anchor points	Dummy (B1,B2)
Required load [g]	6
Required load [N]	7200
Minimum test duration [s]	10
Result	
Test duration [s]	17
Any signs of structural failure	No
Test results	POSITIVE

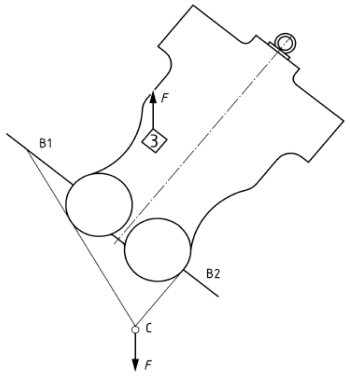
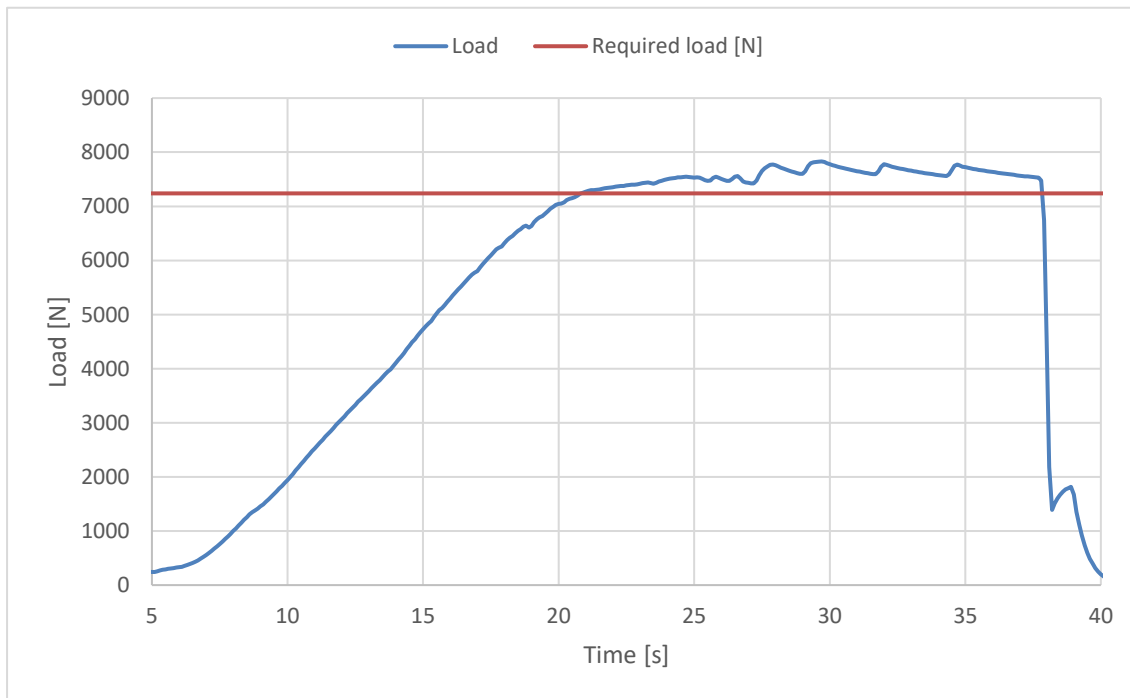
The validation of this test report is given by the signature of the test manager on the Inspection Certificate no 94.20

Inspection certificate number: **PH_374.2022**

model: **MK1 Pro**

Harness Structural test

Test ID 07

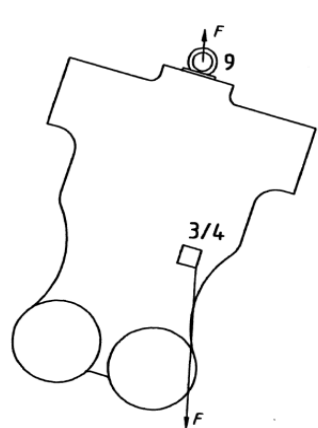
Standard	NfL 2-565-20	
Reference	5.3.2.6	
Test setup	Asymmetric, negative	
Attachment points	One main riser attachment (3 or 4) downwards	
Anchor points	Dummy (9)	
Required load [g]	4.5	
Required load [N]	5400	
Minimum test duration [s]	10	
Result		
Test duration [s]	15.1	
Any signs of structural failure	No	
Test results	POSITIVE	

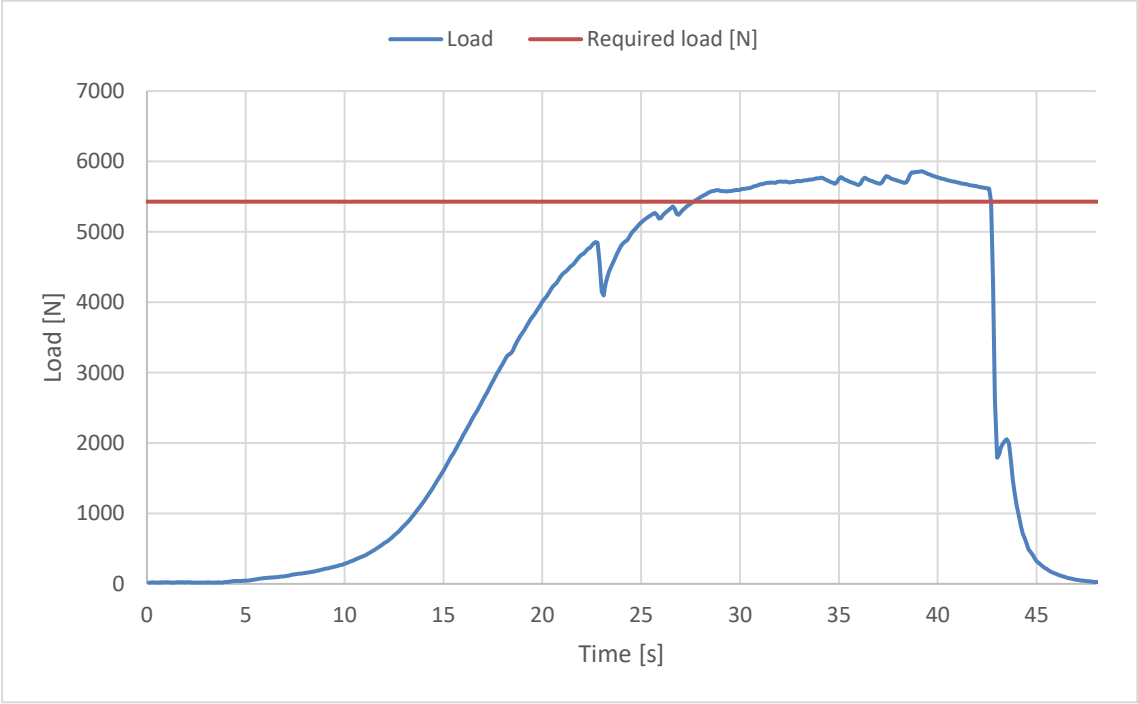

The validation of this test report is given by the signature of the test manager on the Inspection Certificate no 94.20

Inspection certificate number: **PH_374.2022**

model: **MK1 Pro**

Harness Structural test

Test ID 09

Standard	NfL 2-565-20
Reference	5.3.2.4
Test setup	Rescue attachments
Attachment points	Rescue riser attachment (1,2)
Anchor points	Dummy (B1,B2)
Required load [g]	15
Required load [N]	18000
Minimum test duration [s]	5
Result	
Test duration [s]	9.2
Any signs of structural failure	No
Test results	POSITIVE

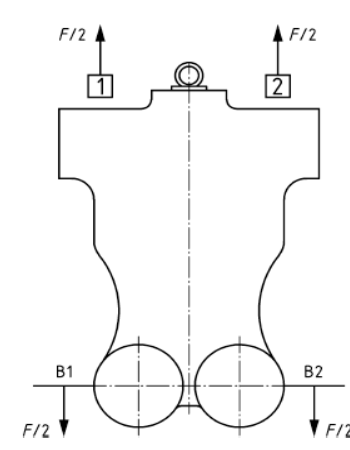
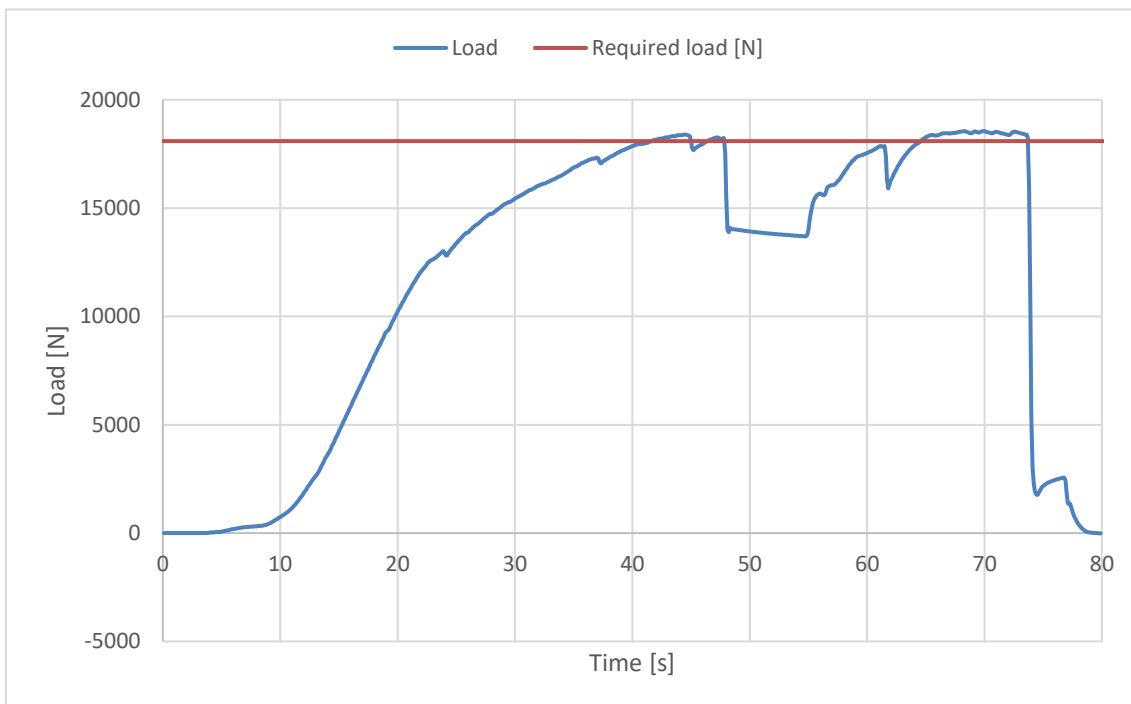
The validation of this test report is given by the signature of the test manager on the Inspection Certificate no 94.20

Inspection certificate number: **PH_374.2022**

model: **MK1 Pro**

Harness Structural test

Test ID 13

Standard	NfL 2-565-20
Reference	5.3.2.7
Test setup	Flying position before landing
Attachment points	Both main riser attachment (3,4)
Anchor points	Dummy (7,8)
Required load [g]	15
Required load [N]	18000
Minimum test duration [s]	5
Result	
Test duration [s]	11
Any signs of structural failure	No
Test results	POSITIVE

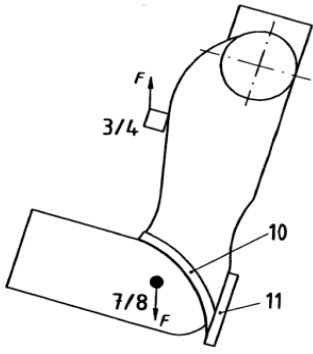
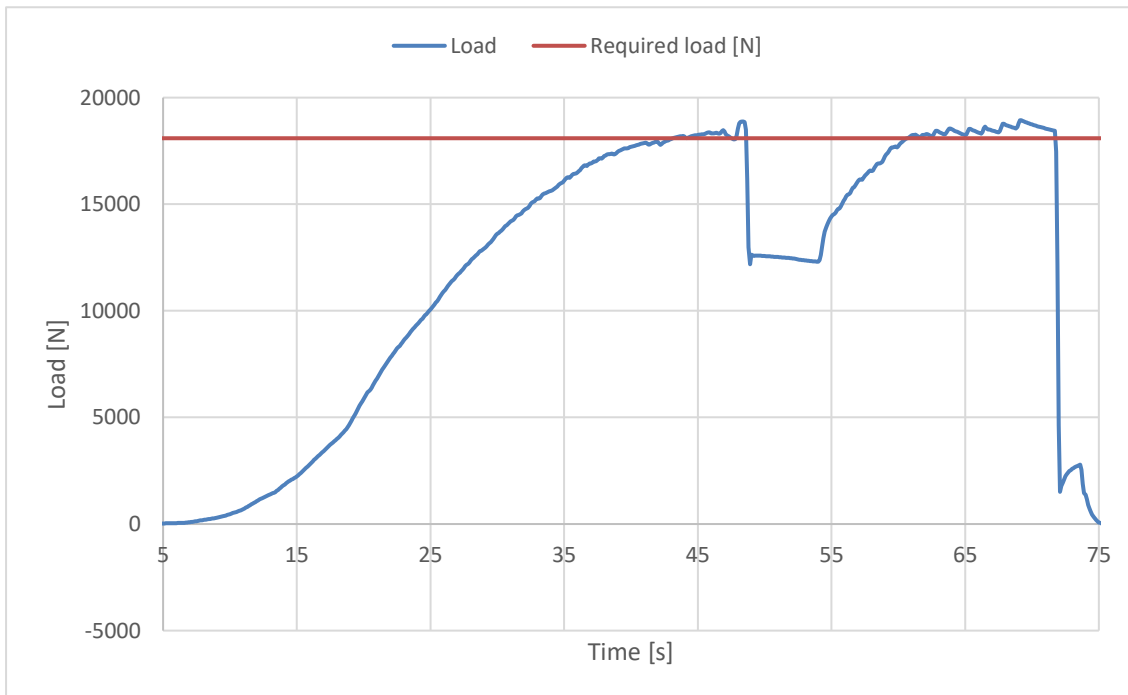
The validation of this test report is given by the signature of the test manager on the Inspection Certificate no 94.20

Inspection certificate number: **PH_374.2022**

model: **MK1 Pro**

Rescue Deployment Test

Test ID RRDT

Standard	NfL 2-565-20
Reference	6.1.5
Test setup	Default flying position
Attachment points	Sensor connect to handle, and pull in opening direction
	The test is to simulate the load required to open the emergency parachute(1st action).
Min. Required load [N]	20
Max. Required load [N]	70
Result	
Load for first action [N]	49.67
Test results	POSITIVE

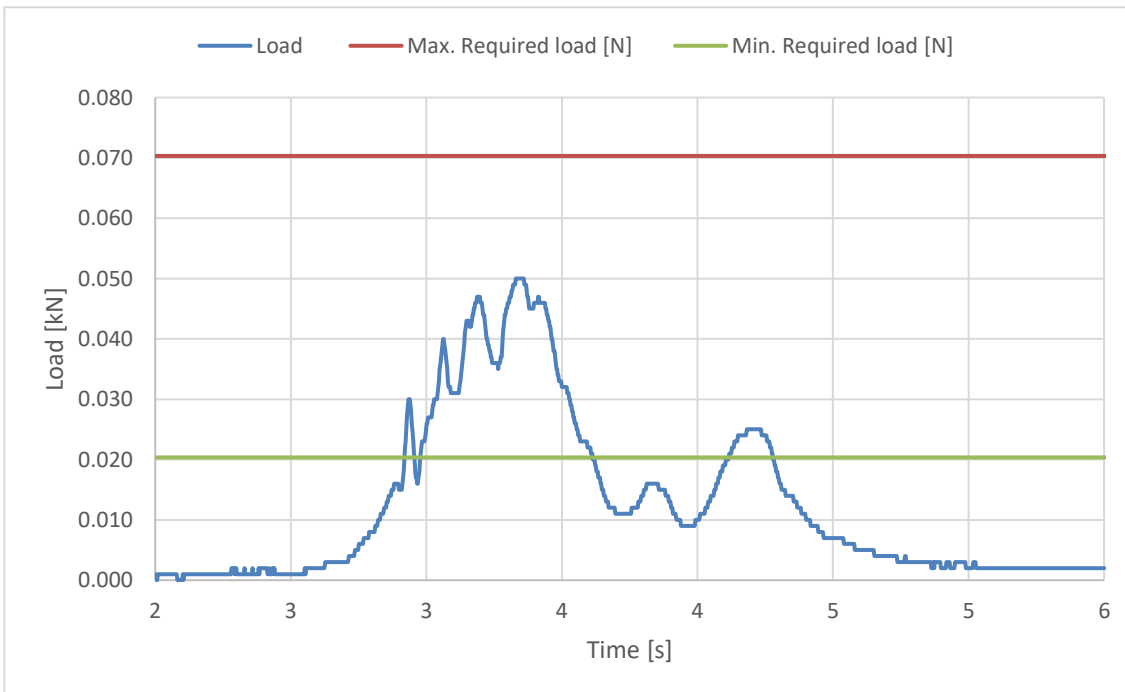

The validation of this test report is given by the signature of the test manager on the Inspection Certificate no 94.20

Inspection certificate number: **PH_374.2022**

model: **MK1 Pro**

Rescue Deployment Handle strength test

Test ID RRST

Standard	EN12491:2015
Reference in standard	5.3.2
Test setup	Two end points of handle
Attachment points	Sensor connect to end of handle, pull on the other side
	The handle must support min 700 N for 10 s, after measure breaking strength
Min. Required load [N]	700
Minimum test duration [s]	10
Result	
Test duration [s]:	14.2
Breaking strength [N]	1126.47
Test results	POSITIVE

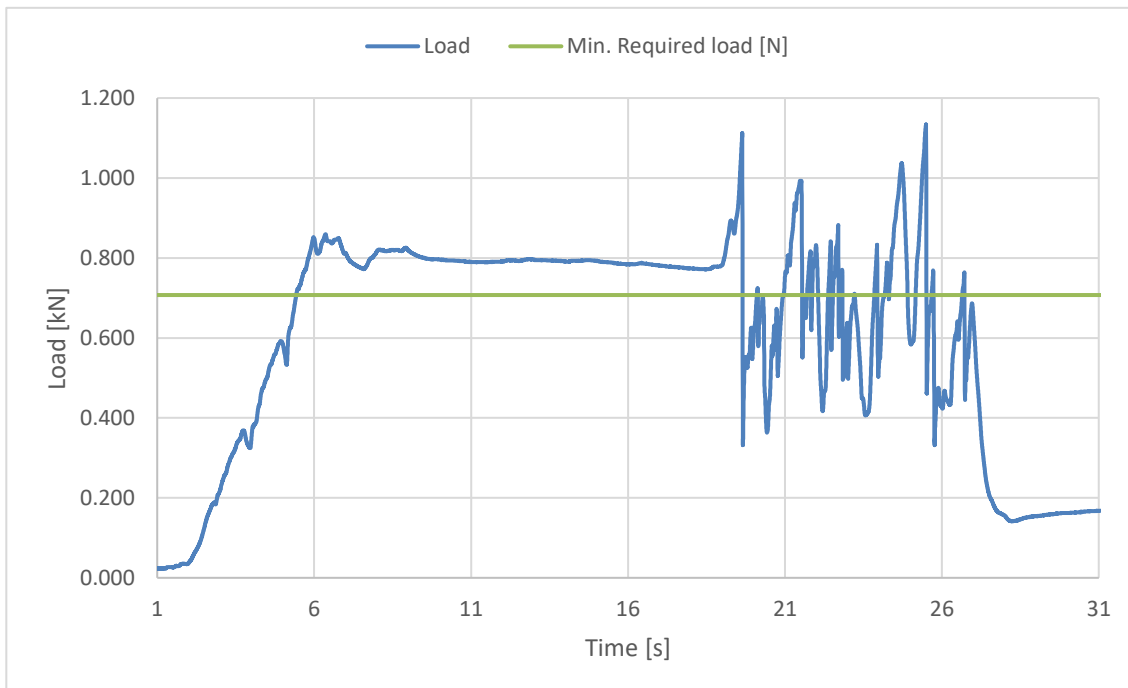

The validation of this test report is given by the signature of the test manager on the Inspection Certificate no 94.20