

Harness Structural test Report - LTF

Inspection certificate number: **PH_300.2020**

Manufacturer data:

Manufacturer name: **Supair SAS**
 Representative: **Laurent Chiabaut**
 Street: **Parc Altais / 34, rue Adrastée**
 Post code place: **74650 Chavanod**
 Country: **France**

Sample data:

Name: **Walibi 3**
 Type: **ABS**
 Size: **M**
 Serial number: **2173SM0404RO**
 Impact pad type: ⁽¹⁾ **Foam**
 Clip-in weight [kg]: **120**

 Date of test: **23.05.2023**

Atmosphere AGL:

[C°]	21
RH [%]	54
[hPa]	1004

Summary of Structural test

Test id	- Ref.	Setup	Req. Load [g]	Req. Load [N]	Min. duration [s]	Result
02	✓ 5.3.2.1	Default flying position	6	7200	10	POSITIVE
03	✓ 5.3.2.2	Default flying position	15	18000	5	POSITIVE
04	✓ 5.3.2.3	Asymmetric, one riser	6	7200	10	POSITIVE
07	✓ 5.3.2.6	Asymmetric, negative	4.5	5400	10	POSITIVE
09	5.3.2.4	Rescue attachments	15	18000	5	n/a
13	✓ 5.3.2.7	Flying position before landing	15	18000	5	POSITIVE
14	5.3.2.5	Towing	5	6000	10	n/a

Rescue deployment test

Test id	- LTF n°L II 91/09	Setup	Min load [N]	Max. load [N]	Measured [N]	Result
RRDT	✓ 6.1.5	Default flying position	20	70	61.46	POSITIVE

Rescue Deployment Handle strength test

Test id	- EN 12491	Setup	Req. Load [N]	Min. duration [s]	Breaking strength [N]	Result
RRST	✓ 5.3.2	Two end points of handle	700	10	2965.07	POSITIVE

Manufacture	Instrument	Type no	S/N	Validity Calibration
HBM	Load Sensor GE01	1-S9M/50KN-1	31314643	04.09.2023
Burster	Sensor Burster	8431-10000	1185483	04.09.2023
JDC elec	Geos n°11 Skywatch	Geos n°11	Unit11	18.06.2025

Air Turquoise SA, having thoroughly assessed the sample mentioned above, declare it was found conform with
 Airworthiness Requirements LTF n°L II 91/09 - EN12491:2015 5.3.2

The validation of this test report is given by the signature of the test manager on the Inspection Certificate no 94.20

⁽¹⁾ If Impact pad available, see test report no. 94.22 and inspection certificate no. 94.20

Calculated value in tests reports include the value minus the uncertainty (on safe side) / The uncertainty stated is the expanded uncertainty obtained by multiplying the standard uncertainty by the coverage factor k = 2. The value of the measurand lies within the assigned range of values with a probability of 95%.

This declaration must not be reproduced in part without the written permission of AIR TURQUOISE SA.

Inspection certificate number: **PH_300.2020**

model: **Walibi 3**

Harness Structural test

Test ID 02

Standard	LTF NfL II 91/09
Reference	5.3.2.1
Test setup	Default flying position
Attachment points	Both main riser attachment (3,4)
Anchor points	Dummy (B1, B2)
Required load [g]	6
Required load [N]	7200
Minimum test duration [s]	10
Result	
Test duration [s]	12.7
Any signs of structural failure	No
Test results	POSITIVE

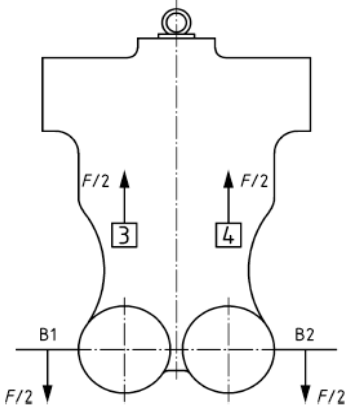
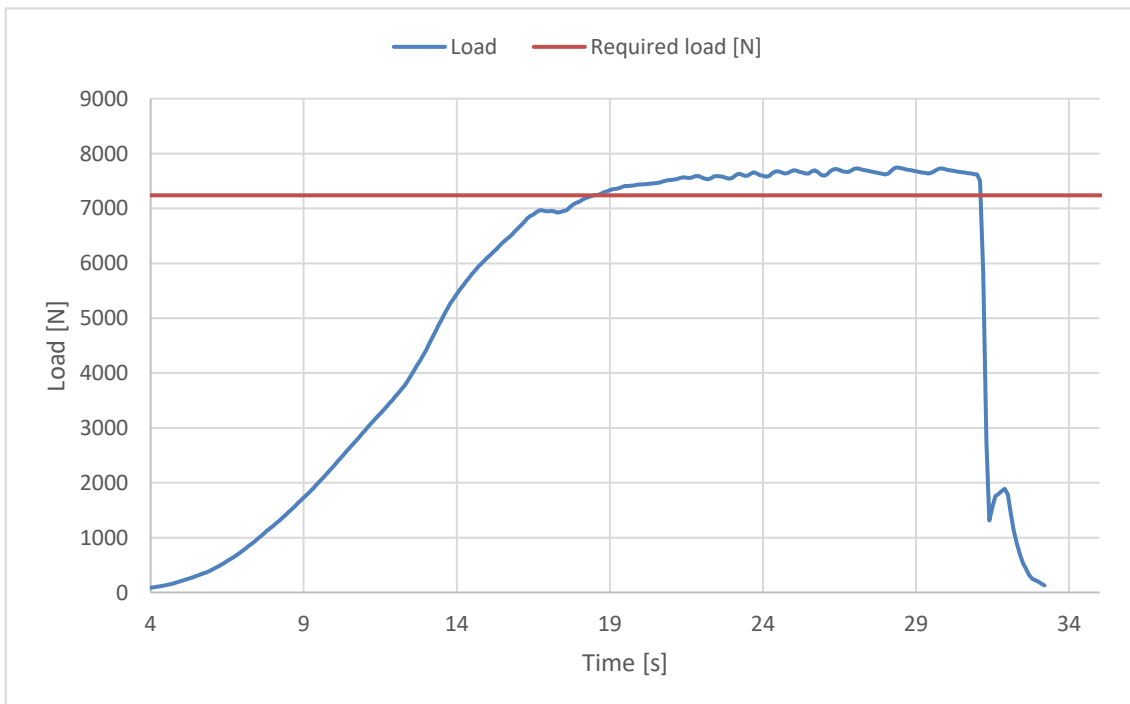
The validation of this test report is given by the signature of the test manager on the Inspection Certificate no 94.20

Inspection certificate number: **PH_300.2020**

model: **Walibi 3**

Harness Structural test

Test ID 03

Standard **LTF NfL II 91/09**
 Reference **5.3.2.2**
 Test setup **Default flying position**
 Attachment points **Both main riser attachment (3,4)**
 Anchor points **Dummy (B1, B2)**

Required load [g] **15**
 Required load [N] **18000**
 Minimum test duration [s] **5**

Result

Test duration [s] **7.4**
 Any signs of structural failure **No**
 Test results **POSITIVE**

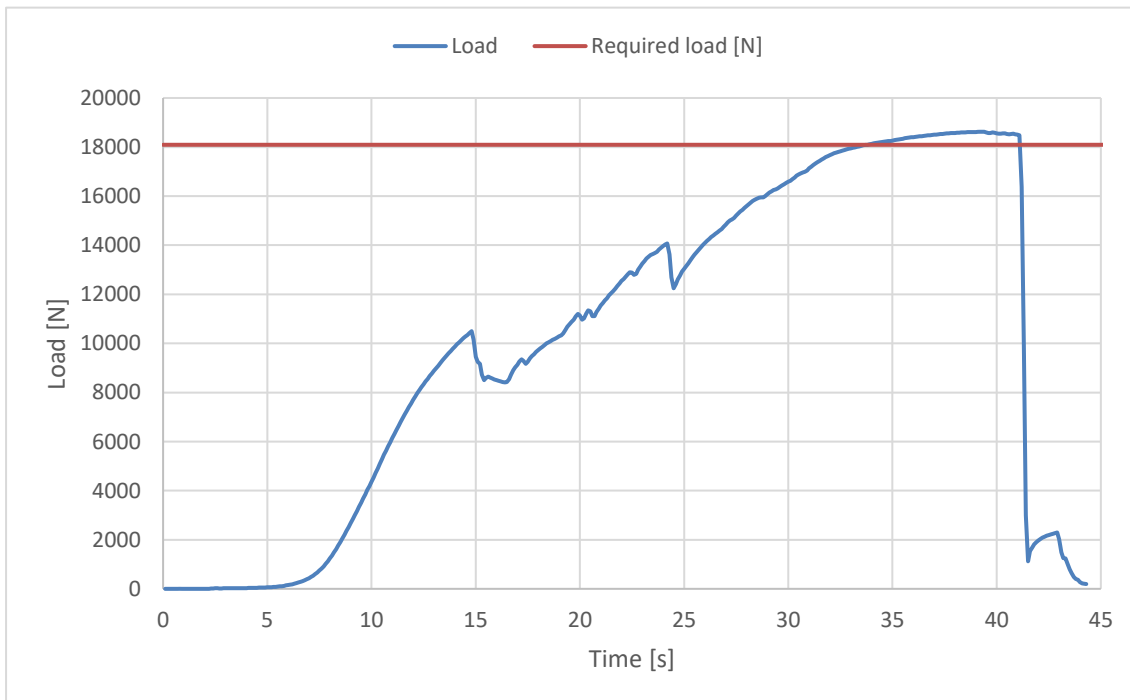
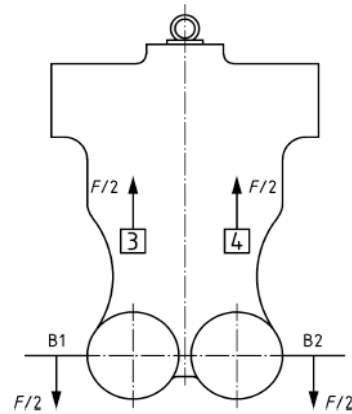

The validation of this test report is given by the signature of the test manager on the Inspection Certificate no 94.20

Inspection certificate number: **PH_300.2020**

model: **Walibi 3**

Harness Structural test

Test ID 04

Standard	LTF NfL II 91/09
Reference	5.3.2.3
Test setup	Asymmetric, one riser
Attachment points	One main riser attachment (3)
Anchor points	Dummy (B1,B2)
Required load [g]	6
Required load [N]	7200
Minimum test duration [s]	10
Result	
Test duration [s]	13.1
Any signs of structural failure	No
Test results	POSITIVE

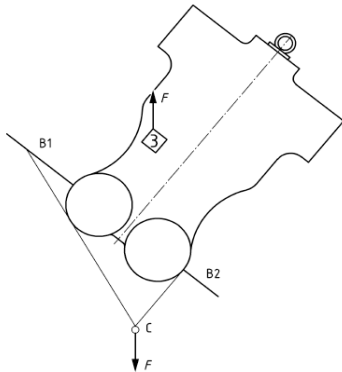
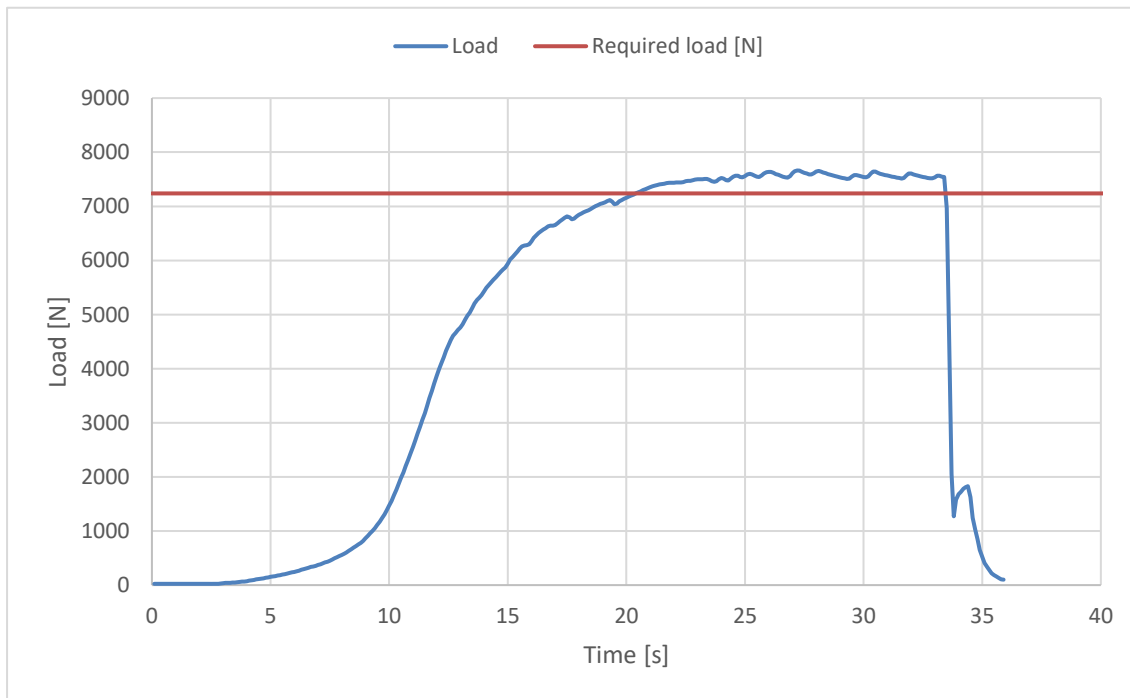
The validation of this test report is given by the signature of the test manager on the Inspection Certificate no 94.20

Inspection certificate number: **PH_300.2020**

model: **Walibi 3**

Harness Structural test

Test ID 07

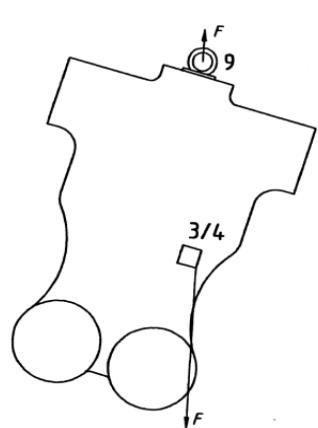
Standard	LTF NfL II 91/09	
Reference	5.3.2.6	
Test setup	Asymmetric, negative	
Attachment points	One main riser attachment (3 or 4) downwards	
Anchor points	Dummy (9)	
Required load [g]	4.5	
Required load [N]	5400	
Minimum test duration [s]	10	
Result		
Test duration [s]	17.8	
Any signs of structural failure	No	
Test results	POSITIVE	

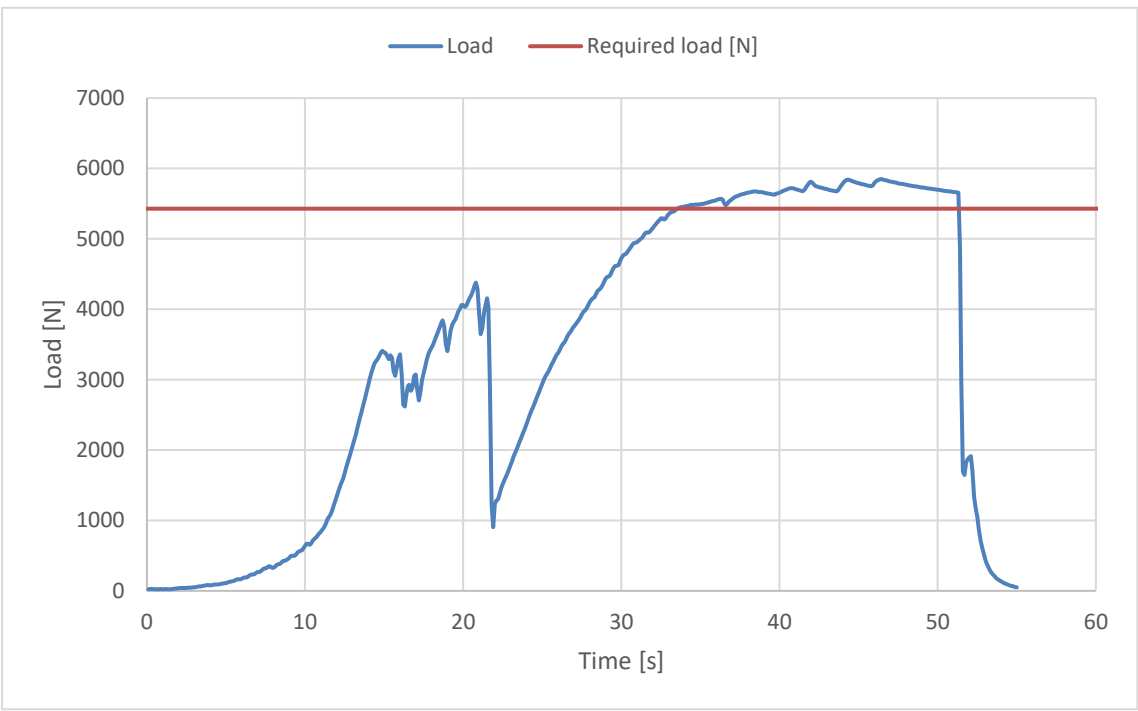

The validation of this test report is given by the signature of the test manager on the Inspection Certificate no 94.20

Inspection certificate number: **PH_300.2020**

model: **Walibi 3**

Harness Structural test

Test ID 13

Standard	LTF NfL II 91/09
Reference	5.3.2.7
Test setup	Flying position before landing
Attachment points	Both main riser attachment (3,4)
Anchor points	Dummy (7,8)
Required load [g]	15
Required load [N]	18000
Minimum test duration [s]	5
Result	
Test duration [s]	7.4
Any signs of structural failure	No
Test results	POSITIVE

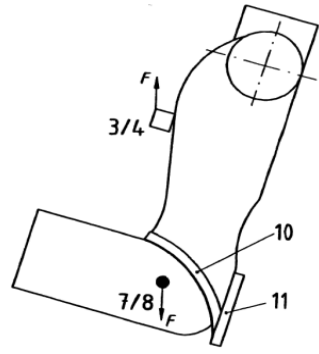
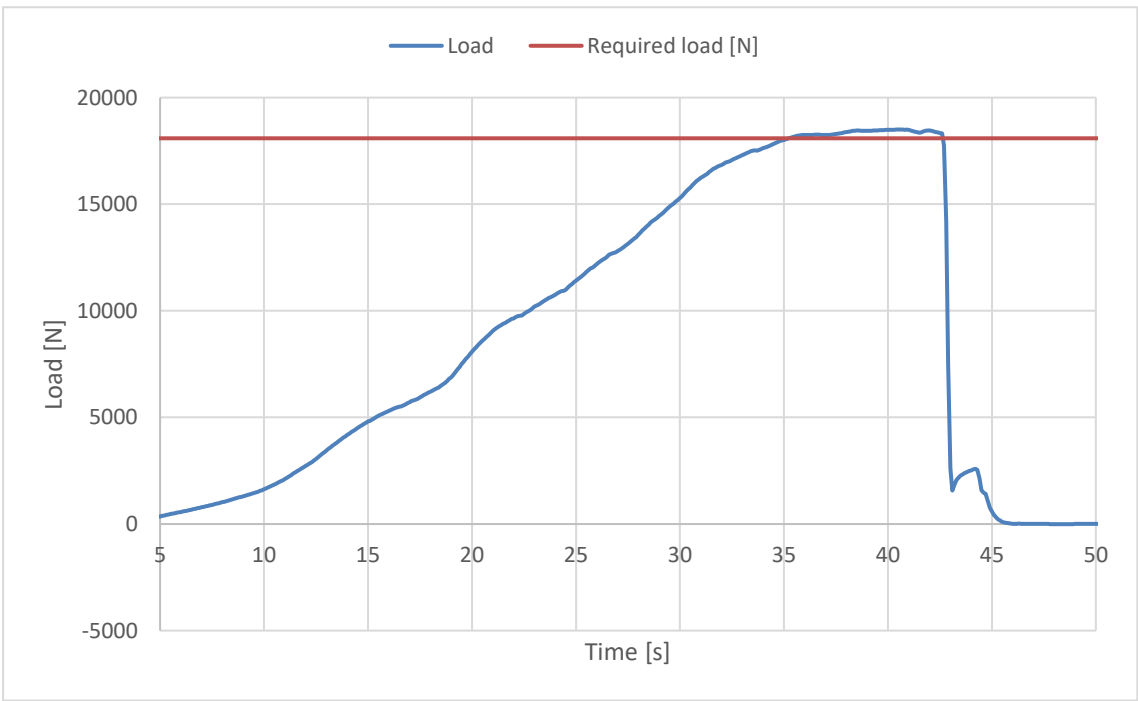
The validation of this test report is given by the signature of the test manager on the Inspection Certificate no 94.20

Inspection certificate number: **PH_300.2020**

model: **Walibi 3**

Rescue Deployment Test

Test ID RRDT

Standard	LTF NfL II 91/09
Reference	6.1.5
Test setup	Default flying position
Attachment points	Sensor connect to handle, and pull in opening direction
	The test is to simulate the load required to open the emergency parachute(1st action).
Min. Required load [N]	20
Max. Required load [N]	70
Result	
Load for first action [N]	61.46
Test results	POSITIVE

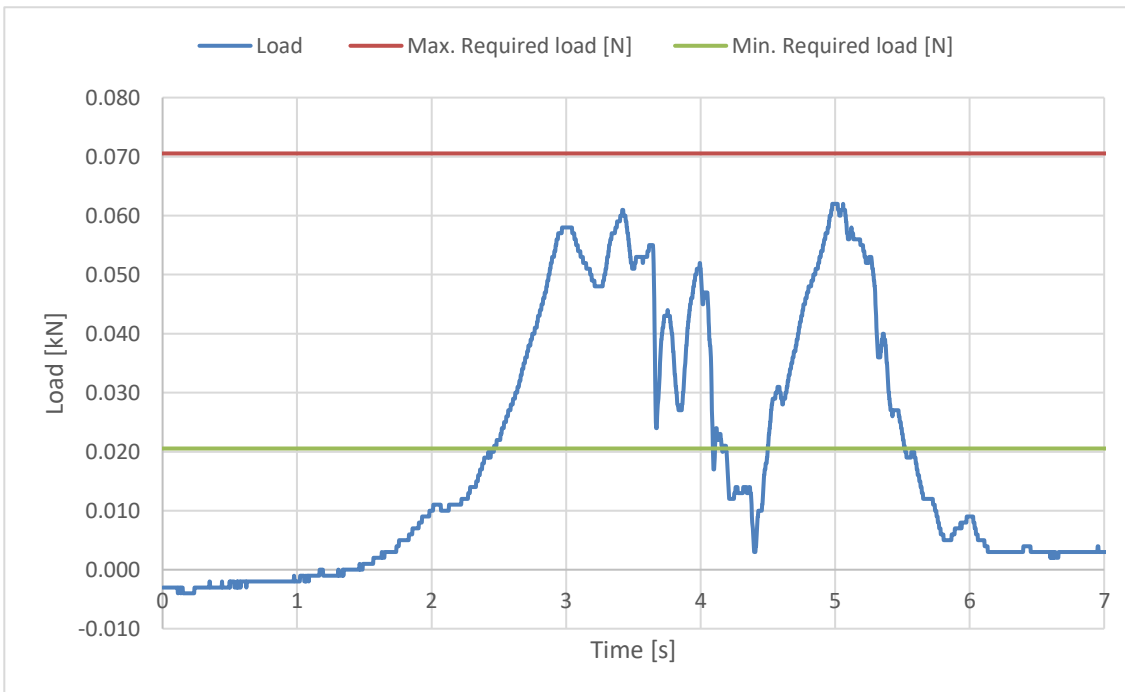

The validation of this test report is given by the signature of the test manager on the Inspection Certificate no 94.20

Inspection certificate number: **PH_300.2020**

model: **Walibi 3**

Rescue Deployment Handle strength test

Test ID RRST

Standard	EN12491:2015
Reference in standard	5.3.2
Test setup	Two end points of handle
Attachment points	Sensor connect to end of handle, pull on the other side
	The handle must support min 700 N for 10 s, after measure breaking strength
Min. Required load [N]	700
Minimum test duration [s]	10
Result	
Test duration [s]:	18.5
Breaking strength [N]	2965.07
Test results	POSITIVE

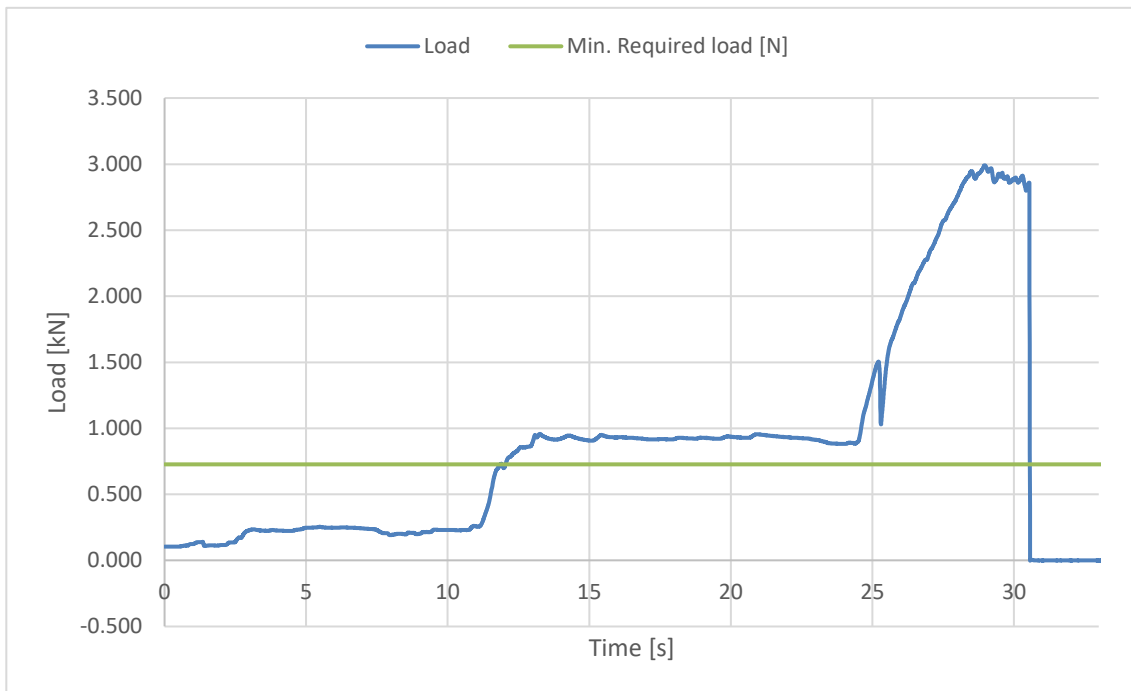

The validation of this test report is given by the signature of the test manager on the Inspection Certificate no 94.20