

Harness Structural test Report - EN

Inspection certificate number: **PH_369.2022**

Manufacturer data:

Manufacturer name: **Skywalk GmbH & Co. KG**
 Representative: **Mr. Arne Wehrlin**
 Street: **Windeckstrasse 4**
 Post code place: **83250 Marquarstein**
 Country: **Germany**

Sample data:

Name: **GUEST**
 Type: **ABS**
 Size: **M**
 Serial number: **SKH-0122-PA-01**
 Impact pad type: ⁽¹⁾ **Inflatable**
 Clip-in weight [kg]: **120**
 Date of test: **25.04.2022**

Atmosphere AGL:

| | |
|--------|------------|
| [C°] | 20 |
| RH [%] | 39 |
| [hPa] | 998 |

Summary of Structural test

| Test id | - EN 1651 | Setup | Req. Load [g] | Req. Load [N] | Min. duration [s] | Result |
|----------------------|-------------------|---------------------------------------|---------------|---------------|-------------------|-----------------|
| 01 ⁽³⁾ | V 5.5.1.1 | Positive symmetric load (Slippage) | 4.5 | 5400 | 5 | POSITIVE |
| 03 ⁽³⁾ | V 5.5.1.1b | Positive symmetric load | 15 | 18000 | 5 | POSITIVE |
| 05 | V 5.5.1.2 | Positive asymmetric load | 6 | 7200 | 5 | POSITIVE |
| 06 | V 5.5.1.6 | Negative symmetric load | 6 | 7200 | 5 | POSITIVE |
| 08 ⁽⁵⁾ | 5.5.1.9 | Anti falling-out system | 4.5 | 5400 | 5 | n/a |
| 09 ⁽³⁾⁽⁴⁾ | 5.5.1.3 | Positive symmetric load rescue points | 15 | 18000 | 5 | n/a |
| 10 ⁽³⁾⁽⁴⁾ | 5.5.1.4 | Negative symmetric load rescue points | 15 | 18000 | 5 | n/a |
| 11 | 5.5.1.8 | Connecting element for rescue | n/a | 24000 | 0.3 | n/a |
| 12 ⁽³⁾ | V 5.5.1.7 | Upright (landing) position load | 6 | 7200 | 5 | POSITIVE |
| 14 | 5.5.1.5 | Negative symmetric load towing points | 5 | 6000 | 5 | n/a |

Rescue deployment test

| Test id | - EN 1651 | Setup | Min. load [N] | Max. load [N] | Measured [N] | Result |
|---------|-----------|-------------------------|---------------|---------------|--------------|------------|
| RRDT | 5.5.1.11 | Default flying position | 20 | 70 | 0.00 | n/a |

Rescue Deployment Handle strength test

| Test id | - EN 12491 | Setup | Req. Load [N] | Min. duration [s] | Break. strength [N] | Result |
|---------|------------|--------------------------|---------------|-------------------|---------------------|------------|
| RRST | 5.3.2 | Two end points of handle | 700 | 10 | 0.00 | n/a |

| Manufacturer | Instrument | Type no | S/N | Validity |
|---------------|----------------------|--------------------|----------|------------|
| HBM | Load Sensor GE01 | 1-S9M/50KN-1 | 31314643 | 23.08.2028 |
| Burster / MTS | Load sensor 10kN SL2 | 8431-6010-N000S000 | 593507 | 23.08.2028 |
| JDC elec | Geos n°11 Skywatch | Geos n°11 | Unit11 | 18.06.2025 |

Air Turquoise SA, has thoroughly tested the sample mentioned above and certifies its conformity with the following standards:

EN1651:2018+A1:2020⁽⁶⁾ and EN12491:2015+A1:2021⁽⁶⁾

The validation of this test report is given by the signature of the test manager on the Inspection Certificate no 94.20b

⁽¹⁾ If Impact pad available, see test report no. 94.22 and inspection certificate no. 94.20b. ⁽³⁾ Slipping test of any adjustable components: No slippage of any adjustable element more than 10 mm at 4500N for 5 s. The marks should be added with a pre-load of 1000N. ⁽⁴⁾ For harness with integrated Y bridle, test in the end loop ⁽⁵⁾ Attach to anti-falling out system without connecting the crotch straps (breast straps)

⁽⁶⁾ These standards are NOT covered by accreditation D-IS-19457-01

Calculated value in tests reports include the value minus the uncertainty (on safe side) / The uncertainty stated is the expanded uncertainty obtained by multiplying the standard uncertainty by the coverage factor k = 2. The value of the measurand lies within the assigned range of values with a probability of 95%

This declaration must not be reproduced in part without the written permission of AIR TURQUOISE SA

Inspection certificate number: **PH_369.2022**

model: **GUEST**

Harness Structural test

Test ID 01

| | |
|---------------------------------|-------------------------------------------|
| Standard | EN 1651 |
| Reference in standard | 5.5.1.1 |
| Test setup | Positive symmetric load (Slippage) |
| Attachment points | Both main riser attachment (3,4) |
| Anchor points | Dummy (B1, B2) |
| Required load [g] | 4.5 |
| Required load [N] | 5400 |
| Minimum test duration [s] | 5 |
| Result | |
| Test duration [s] | 32.2 |
| Any signs of structural failure | No |
| Slippery test OK | Yes |
| Test results | POSITIVE |

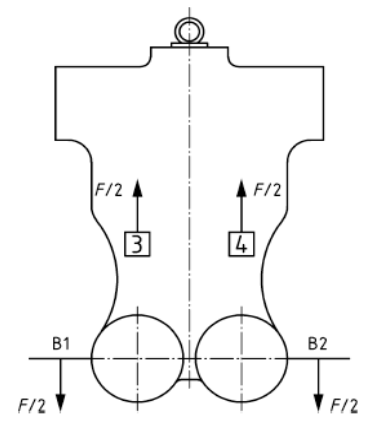
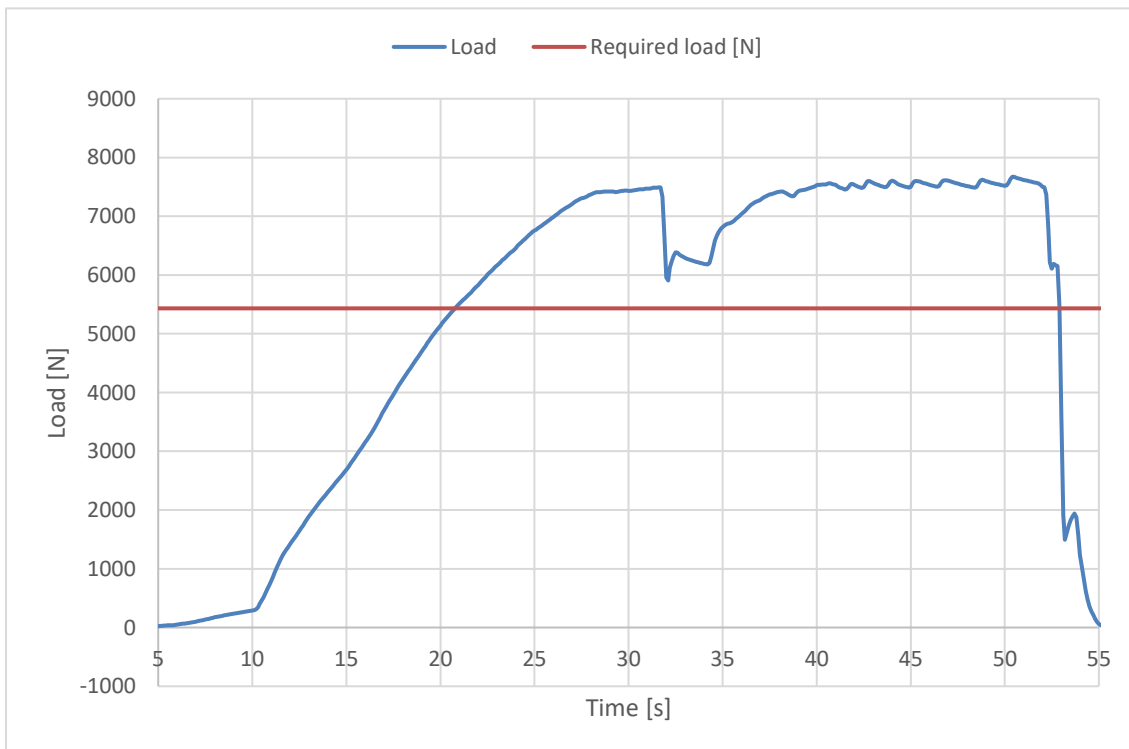
The validation of this test report is given by the signature of the test manager on the Inspection Certificate no 94.20b

Inspection certificate number: **PH_369.2022**

model: **GUEST**

Harness Structural test

Test ID 03

Standard **EN 1651**
 Reference in standard **5.5.1.1b**
 Test setup **Positive symmetric load**
 Attachment points **Both main riser attachment (3,4)**
 Anchor points **Dummy (B1, B2)**

Required load [g] **15**
 Required load [N] **18000**
 Minimum test duration [s] **5**

Result

Test duration [s] **8.4**
 Any signs of structural failure **No**
 Slippery test OK **Yes**
 Test results **POSITIVE**

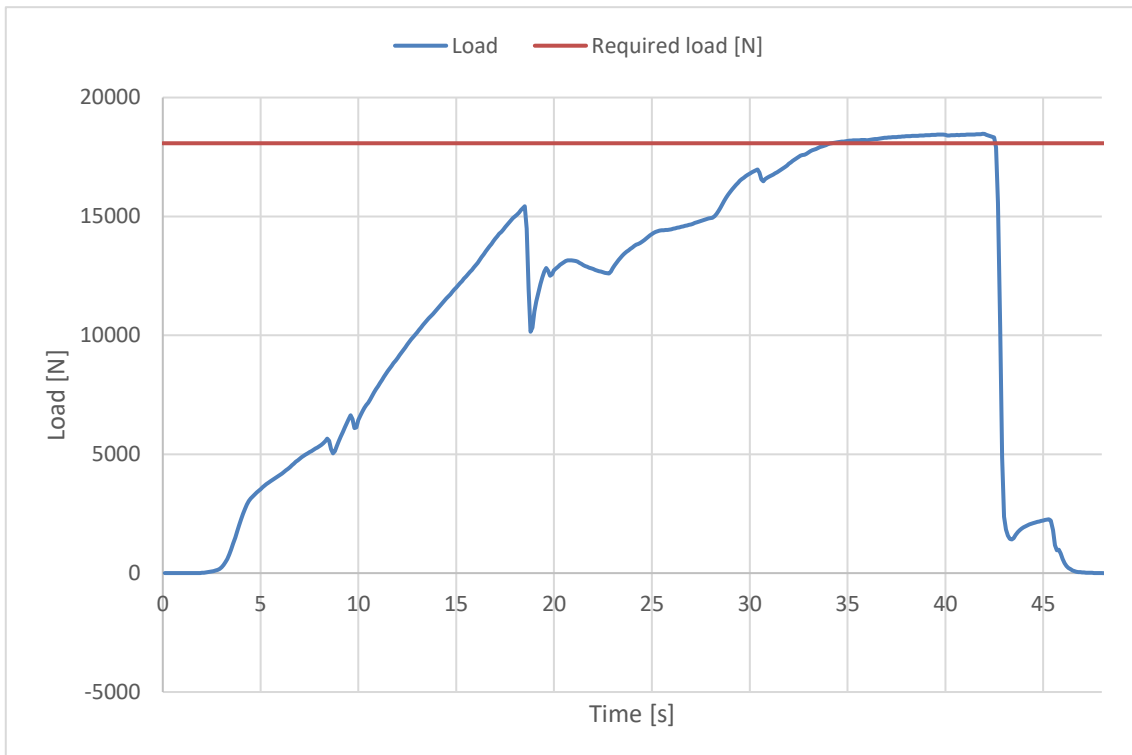
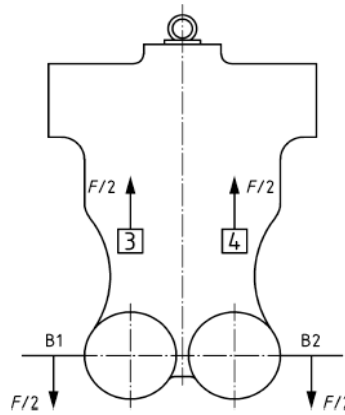

The validation of this test report is given by the signature of the test manager on the Inspection Certificate no 94.20b

Inspection certificate number: **PH_369.2022**

model: **GUEST**

Harness Structural test

Test ID 05

| | |
|---------------------------------|--------------------------------------|
| Standard | EN 1651 |
| Reference in standard | 5.5.1.2 |
| Test setup | Positive asymmetric load |
| Attachment points | One riser attachment (3 or 4) |
| Anchor points | Dummy (C) |
| Required load [g] | 6 |
| Required load [N] | 7200 |
| Minimum test duration [s] | 5 |
| Result | |
| Test duration [s] | 12.6 |
| Any signs of structural failure | No |
| Test results | POSITIVE |

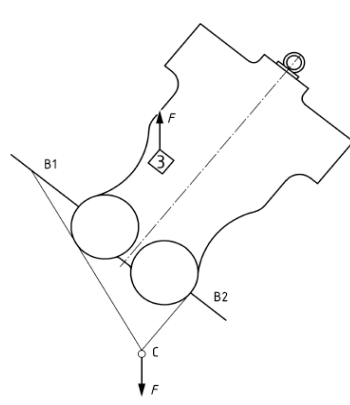
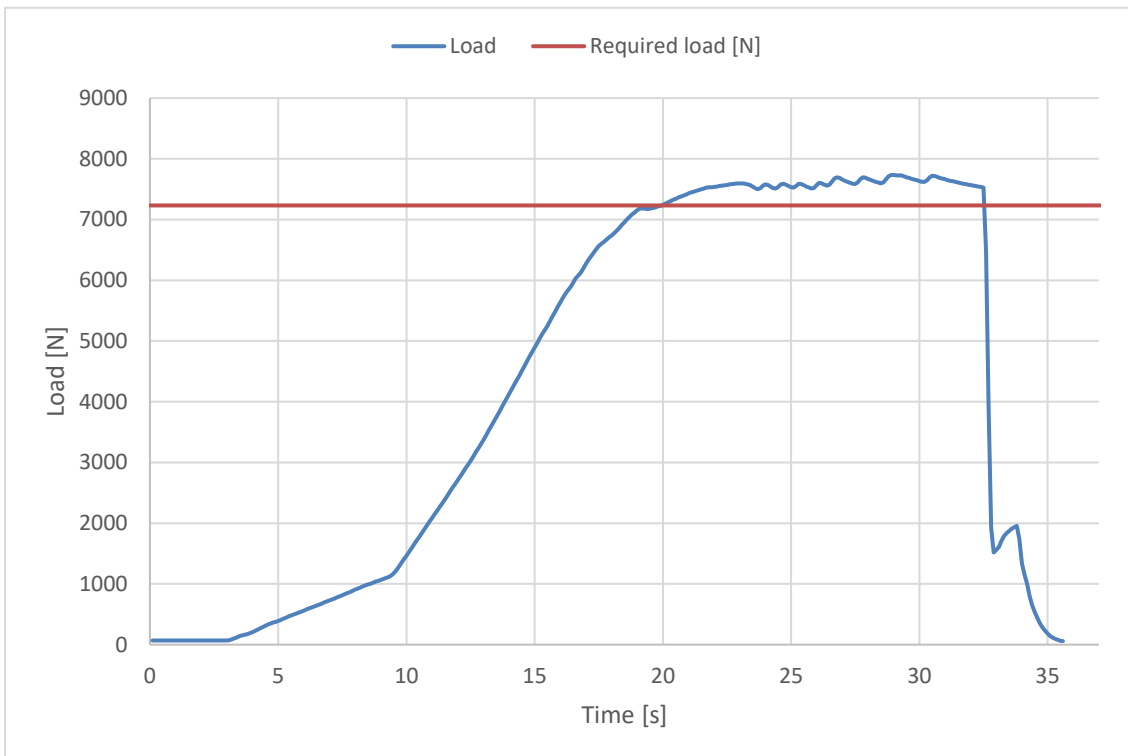
The validation of this test report is given by the signature of the test manager on the Inspection Certificate no 94.20b

Inspection certificate number: **PH_369.2022**

model: **GUEST**

Harness Structural test

Test ID 06

Standard **EN 1651**
 Reference in standard **5.5.1.6**
 Test setup **Negative symmetric load**
 Attachment points **Both main riser attachment (3,4)**
 Anchor points **Dummy (A)**

Required load [g] **6**
 Required load [N] **7200**
 Minimum test duration [s] **5**

Result

Test duration [s] **10.5**
 Any signs of structural failure **No**
 Test results **POSITIVE**

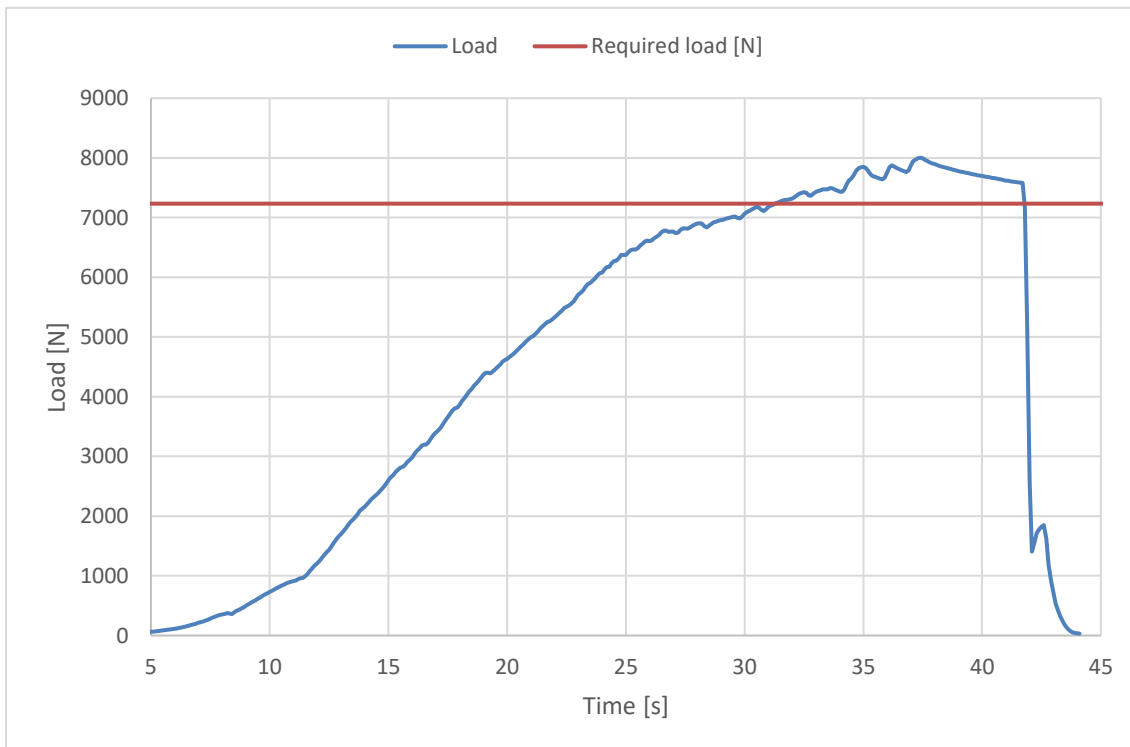
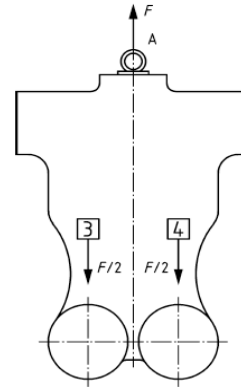

The validation of this test report is given by the signature of the test manager on the Inspection Certificate no 94.20b

Inspection certificate number: **PH_369.2022**

model: **GUEST**

Harness Structural test

Test ID 12

| | |
|---------------------------------|--------------------------------------------|
| Standard | EN 1651 |
| Reference in standard | 5.5.1.7 |
| Test setup | Upright (landing) position load |
| Attachment points | Both main riser attachment (3, 4) |
| Anchor points | Both legstrap of harness (no dummy) |
| Required load [g] | 6 |
| Required load [N] | 7200 |
| Minimum test duration [s] | 5 |
| Harness type | type c |
| Result | |
| Test duration [s] | 12.3 |
| Any signs of structural failure | No |
| Slippery test OK | Yes |
| Test results | POSITIVE |

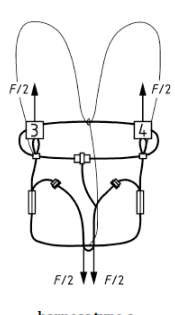
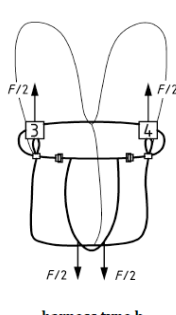
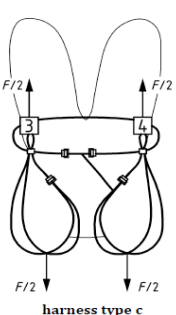

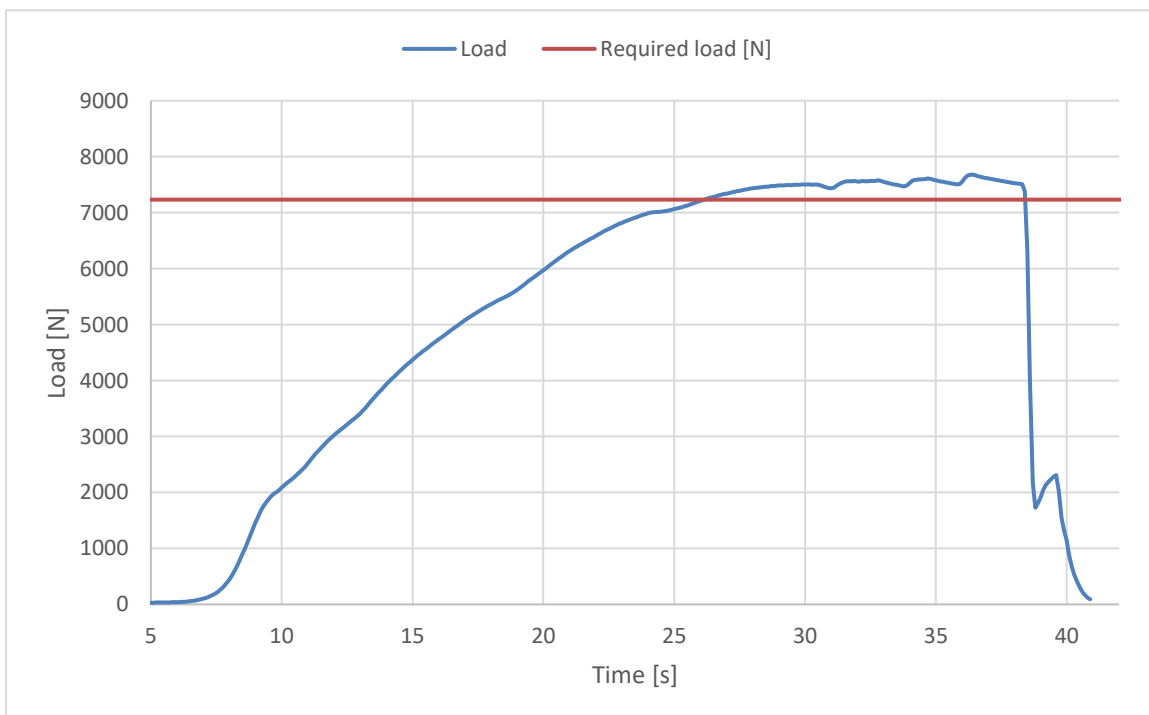
The validation of this test report is given by the signature of the test manager on the Inspection Certificate no 94.20b