

## Harness Structural test Report - EN

Inspection certificate number: **PH\_366.2022**

### Manufacturer data:

Manufacturer name: **Ozone Gliders**  
 Representative: **Russell Ogden**  
 Street: **2, Queens Drive**  
 Post code place: **LA46LN**  
 Country: **UK**

### Sample data:

Name: **Halo**  
 Type: **ABS**  
 Size: **M**  
 Serial number: **Halo-PROTO 1**  
 Impact pad type: <sup>(1)</sup> **Foam**  
 Clip-in weight [kg]: **140**

Date of test: **21.02.2023**

### Atmosphere AGL:

[C°]	<b>20</b>
RH [%]	<b>34</b>
[hPa]	<b>1010</b>

### Summary of Structural test

Test id	- EN 1651	Setup	Req. Load [g]	Req. Load [N]	Min. duration [s]	Result
01 <sup>(3)</sup>	✓ 5.5.1.1	Positive symmetric load (Slippage)	4.5	6300	5	POSITIVE
03 <sup>(3)</sup>	✓ 5.5.1.1b	Positive symmetric load	15	21000	5	POSITIVE
05	✓ 5.5.1.2	Positive asymmetric load	6	8400	5	POSITIVE
06	✓ 5.5.1.6	Negative asymmetric load	6	8400	5	POSITIVE
08 <sup>(5)</sup>	✓ 5.5.1.9	Anti falling-out system	4.5	6300	5	POSITIVE
09 <sup>(3)(4)</sup>	✓ 5.5.1.3	Positive symmetric load rescue points	15	21000	5	POSITIVE
10 <sup>(3)(4)</sup>	5.5.1.4	Negative symmetric load rescue points	15	21000	5	n/a
11	5.5.1.8	Connecting element for rescue	n/a	24000	0.3	n/a
12 <sup>(3)</sup>	✓ 5.5.1.7	Upright (landing) position load	6	8400	5	POSITIVE
14	5.5.1.5	Negative symmetric load towing points	5	7000	5	n/a

### Rescue deployment test

Test id	- EN 1651	Setup	Min load [N]	Max. load [N]	Measured [N]	Result
RRDT	✓ 5.5.1.11	Default flying position	20	70	43.29	POSITIVE

### Rescue Deployment Handle strength test

Test id	- EN 12491	Setup	Req. Load [N]	Min. duration [s]	Breaking strength [N]	Result
RRST	✓ 5.3.2	Two end points of handle	700	10	1389.71	POSITIVE

Manufacturer	Instrument	Type no	S/N	Validity
HBM	Load Sensor GE01	1-S9M/50KN-1	31314643	04.09.2023
Burster / MTS	Load sensor 10kN SL2	8431-6010-N000S000	593507	21.04.2026
JDC elec	Geos n°11 Skywatch	Geos n°11	Unit11	18.06.2025

Air Turquoise SA, has thoroughly tested the sample mentioned above and certifies its conformity with the following standards:

**EN1651:2018+A1:2020<sup>(6)</sup> and EN12491:2015+A1:2021<sup>(6)</sup>**

The validation of this test report is given by the signature of the test manager on the Inspection Certificate no 94.20b

<sup>(1)</sup> If Impact pad available, see test report no. 94.22 and inspection certificate no. 94.20b. <sup>(3)</sup> Slipping test of any adjustable components: No slippage of any adjustable element more than 10 mm at 4500N for 5 s. The marks should be added with a pre-load of 1000N. <sup>(4)</sup> For harness with integrated Y bridle, test in the end loop <sup>(5)</sup> Attach to anti-falling out system without connecting the crotch straps (breast straps)

<sup>(6)</sup> These standards are NOT covered by accreditation D-IS-19457-01

Calculated value in tests reports include the value minus the uncertainty (on safe side) / The uncertainty stated is the expanded uncertainty obtained by multiplying the standard uncertainty by the coverage factor k = 2. The value of the measurand lies within the assigned range of values with a probability of 95%

This declaration must not be reproduced in part without the written permission of AIR TURQUOISE SA

Inspection certificate number: **PH\_366.2022**

model: **Halo**

**Harness Structural test**

**Test ID 01**

Standard	<b>EN 1651</b>
Reference in standard	<b>5.5.1.1</b>
Test setup	<b>Positive symmetric load (Slippage)</b>
Attachment points	<b>Both main riser attachment (3,4)</b>
Anchor points	<b>Dummy (B1, B2)</b>
Required load [g]	<b>4.5</b>
Required load [N]	<b>6300</b>
Minimum test duration [s]	<b>5</b>
<b>Result</b>	
Test duration [s]	<b>18.9</b>
Any signs of structural failure	<b>No</b>
Slippery test OK	<b>Yes</b>
Test results	<b>POSITIVE</b>

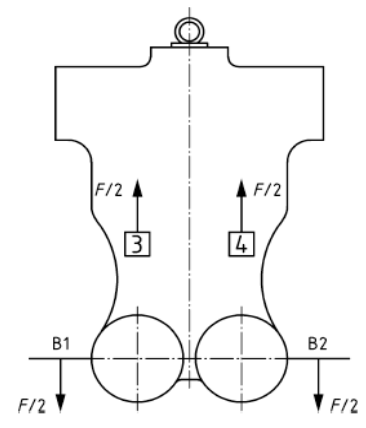
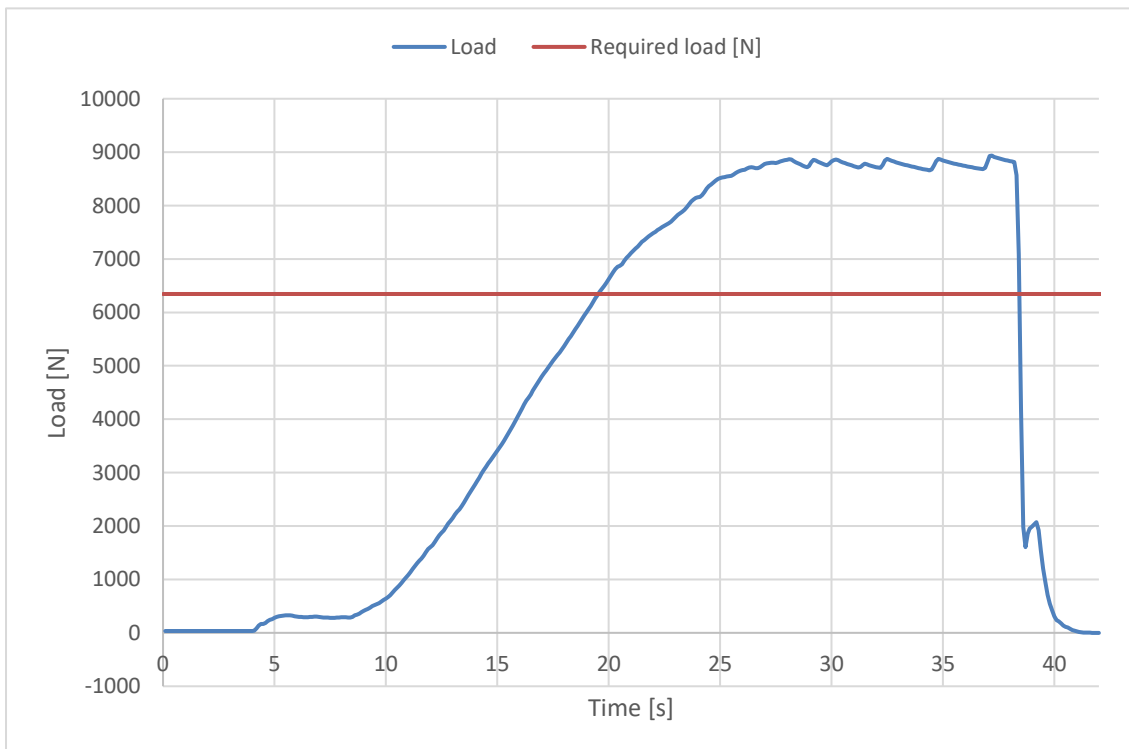
The validation of this test report is given by the signature of the test manager on the Inspection Certificate no 94.20b

Inspection certificate number: **PH\_366.2022**

model: **Halo**

**Harness Structural test**

**Test ID 03**

Standard **EN 1651**  
 Reference in standard **5.5.1.1b**  
 Test setup **Positive symmetric load**  
 Attachment points **Both main riser attachment (3,4)**  
 Anchor points **Dummy (B1, B2)**

Required load [g] **15**  
 Required load [N] **21000**  
 Minimum test duration [s] **5**

**Result**

Test duration [s] **14.8**  
 Any signs of structural failure **No**  
 Slippery test OK **Yes**  
 Test results **POSITIVE**

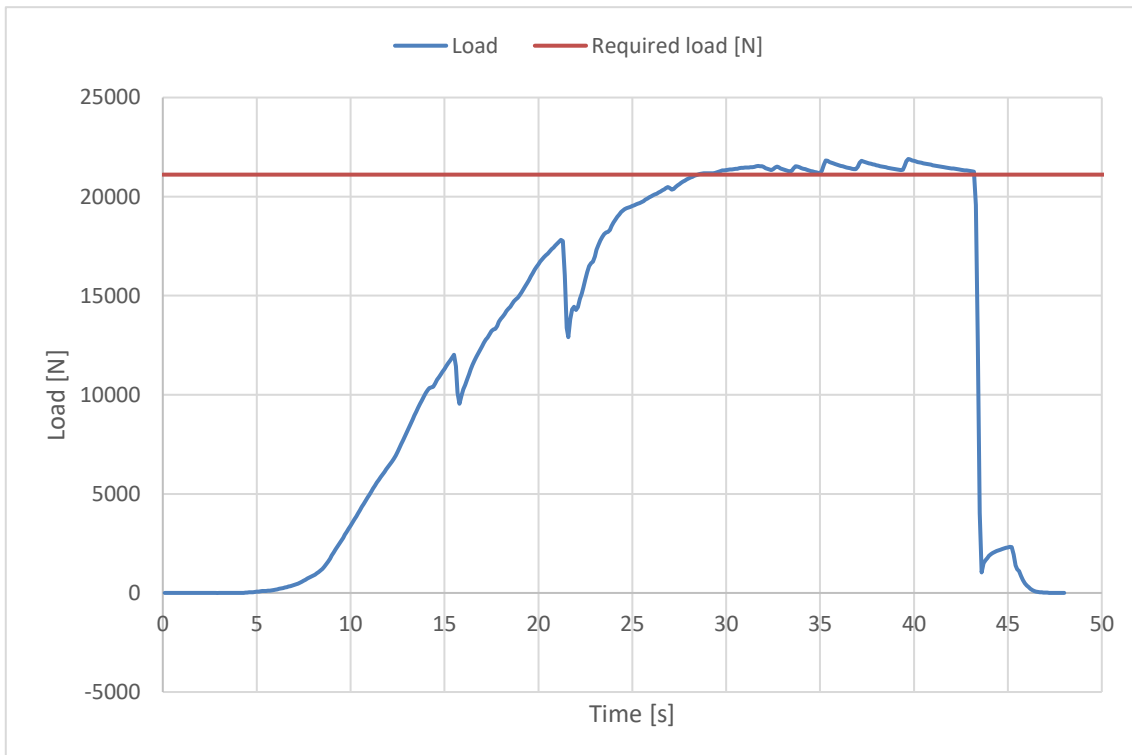
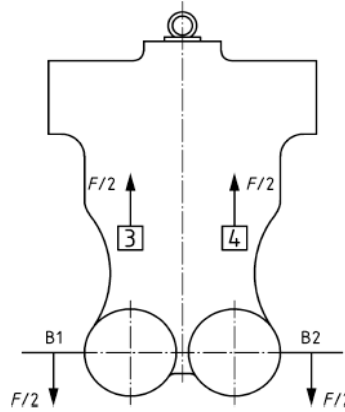

The validation of this test report is given by the signature of the test manager on the Inspection Certificate no 94.20b

Inspection certificate number: **PH\_366.2022**

model: **Halo**

**Harness Structural test**

**Test ID 05**

Standard	<b>EN 1651</b>
Reference in standard	<b>5.5.1.2</b>
Test setup	<b>Positive asymmetric load</b>
Attachment points	<b>One riser attachment (3 or 4)</b>
Anchor points	<b>Dummy (C)</b>
Required load [g]	<b>6</b>
Required load [N]	<b>8400</b>
Minimum test duration [s]	<b>5</b>
<b>Result</b>	
Test duration [s]	<b>13.4</b>
Any signs of structural failure	<b>No</b>
Test results	<b>POSITIVE</b>

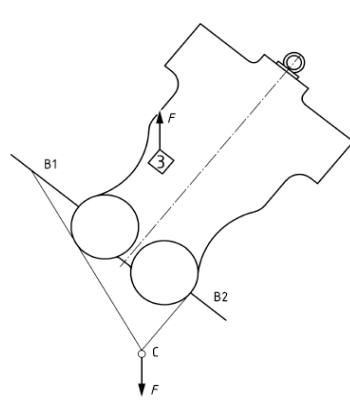
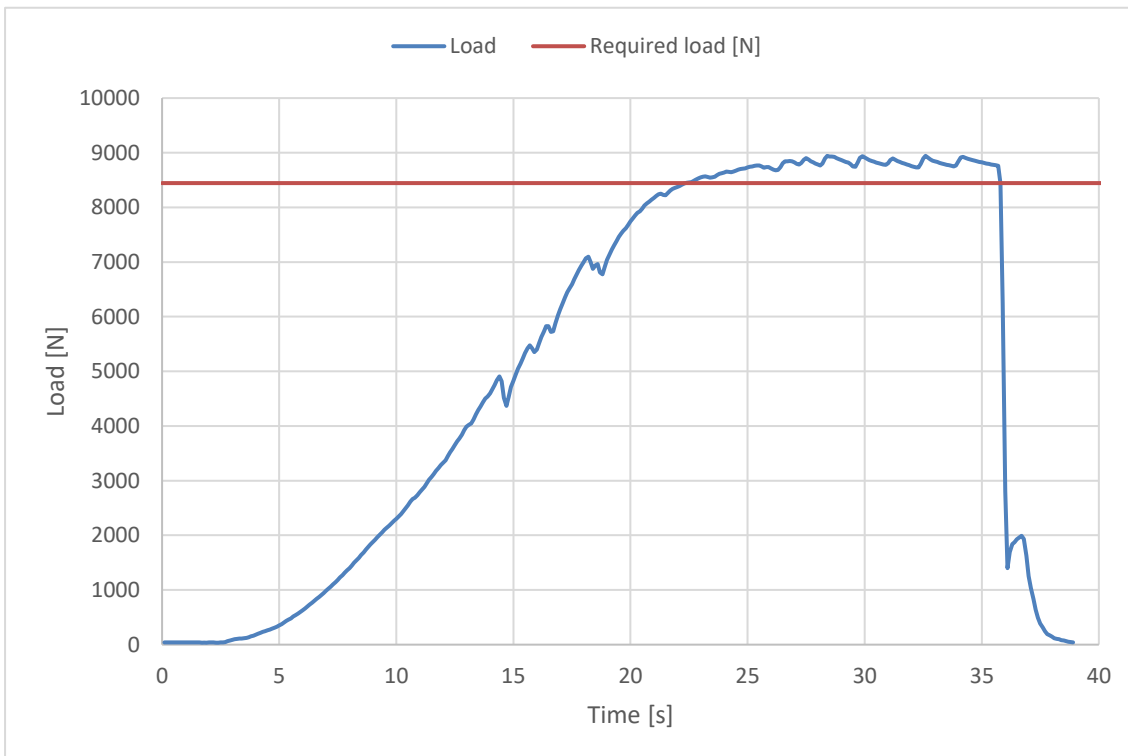
The validation of this test report is given by the signature of the test manager on the Inspection Certificate no 94.20b

Inspection certificate number: **PH\_366.2022**

model: **Halo**

**Harness Structural test**

**Test ID 06**

Standard	<b>EN 1651</b>
Reference in standard	<b>5.5.1.6</b>
Test setup	<b>Negative symmetric load</b>
Attachment points	<b>Both main riser attachment (3,4)</b>
Anchor points	<b>Dummy (A)</b>
Required load [g]	<b>6</b>
Required load [N]	<b>8400</b>
Minimum test duration [s]	<b>5</b>
<b>Result</b>	
Test duration [s]	<b>9.5</b>
Any signs of structural failure	<b>No</b>
Test results	<b>POSITIVE</b>

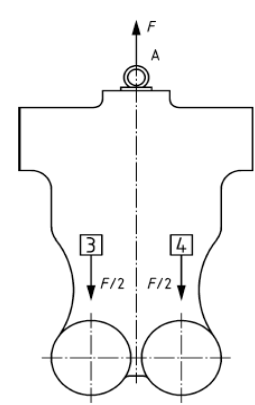
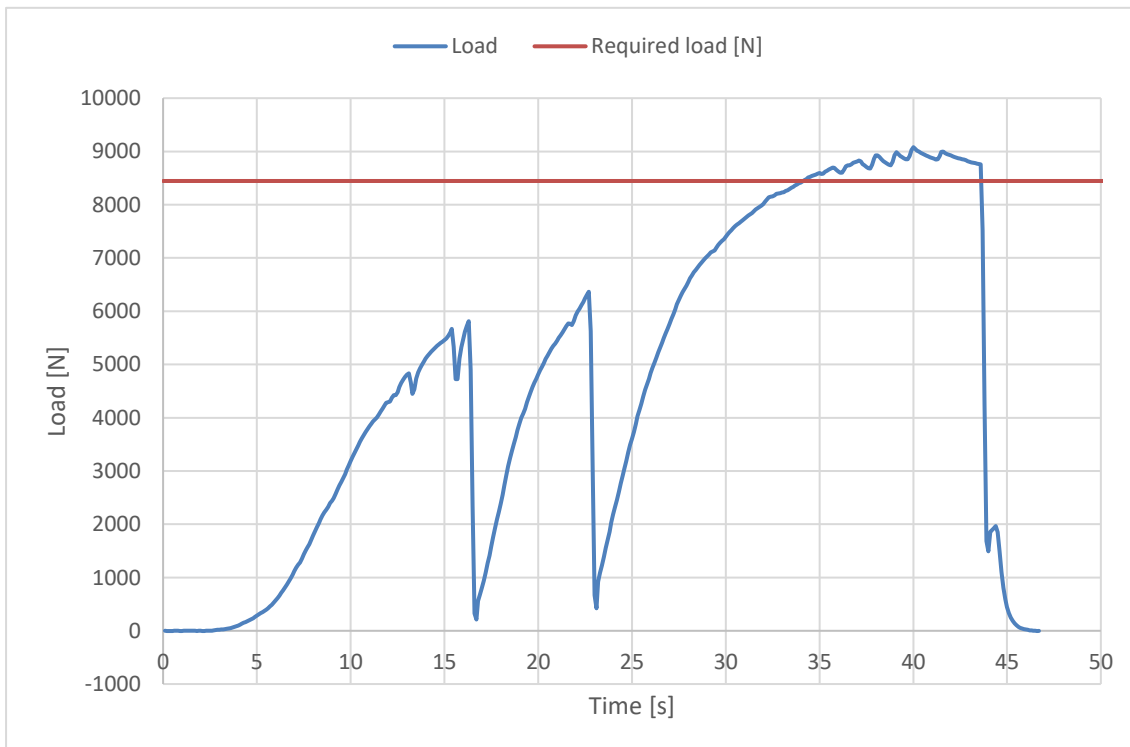
The validation of this test report is given by the signature of the test manager on the Inspection Certificate no 94.20b

Inspection certificate number: **PH\_366.2022**

model: **Halo**

**Harness Structural test**

**Test ID 08**

Standard	<b>EN 1651</b>
Reference in standard	<b>5.5.1.9</b>
Test setup	<b>Anti falling-out system</b>
Attachment points	<b>Around anti falling-out system</b>
Anchor points	<b>Both main riser attachment (no dummy)</b>
Required load [g]	<b>4.5</b>
Required load [N]	<b>6300</b>
Minimum test duration [s]	<b>5</b>
<b>Result</b>	
Test duration [s]	<b>11.3</b>
Any signs of structural failure	<b>No</b>
Test results	<b>POSITIVE</b>

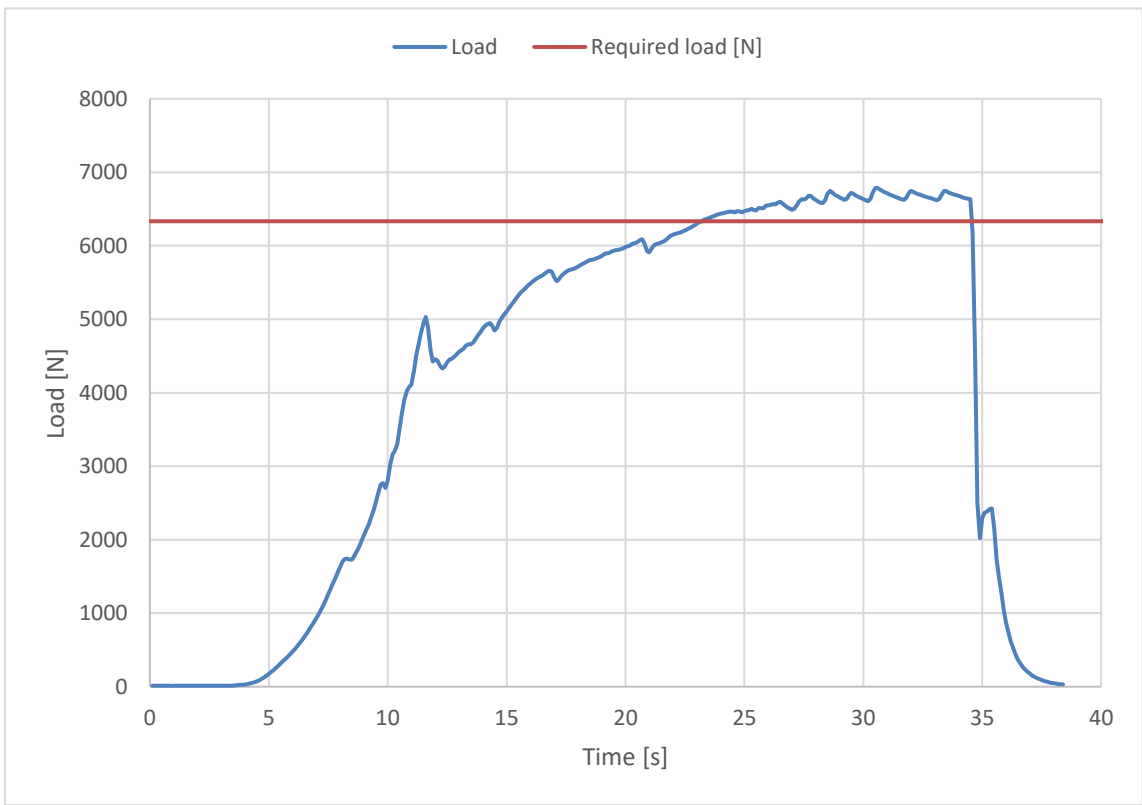

The validation of this test report is given by the signature of the test manager on the Inspection Certificate no 94.20b

Inspection certificate number: **PH\_366.2022**

model: **Halo**

**Harness Structural test**

**Test ID 09**

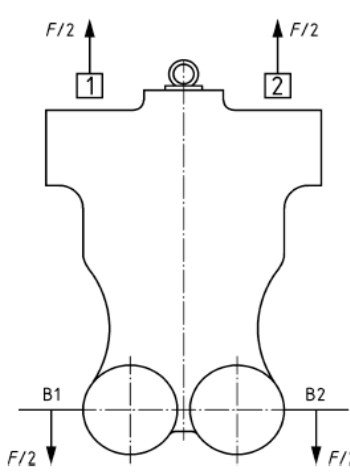
Standard	<b>EN 1651</b>	
Reference in standard	<b>5.5.1.3</b>	
Test setup	<b>Positive symmetric load rescue points</b>	
Attachment points	<b>Both main riser attachment (1,2)</b>	
Anchor points	<b>Dummy (B1,B2)</b>	
Required load [g]	<b>15</b>	
Required load [N]	<b>21000</b>	
Minimum test duration [s]	<b>5</b>	
<b>Result</b>		
Test duration [s]	<b>6.8</b>	
Any signs of structural failure	<b>No</b>	
Slippery test OK	<b>Yes</b>	
Test results	<b>POSITIVE</b>	

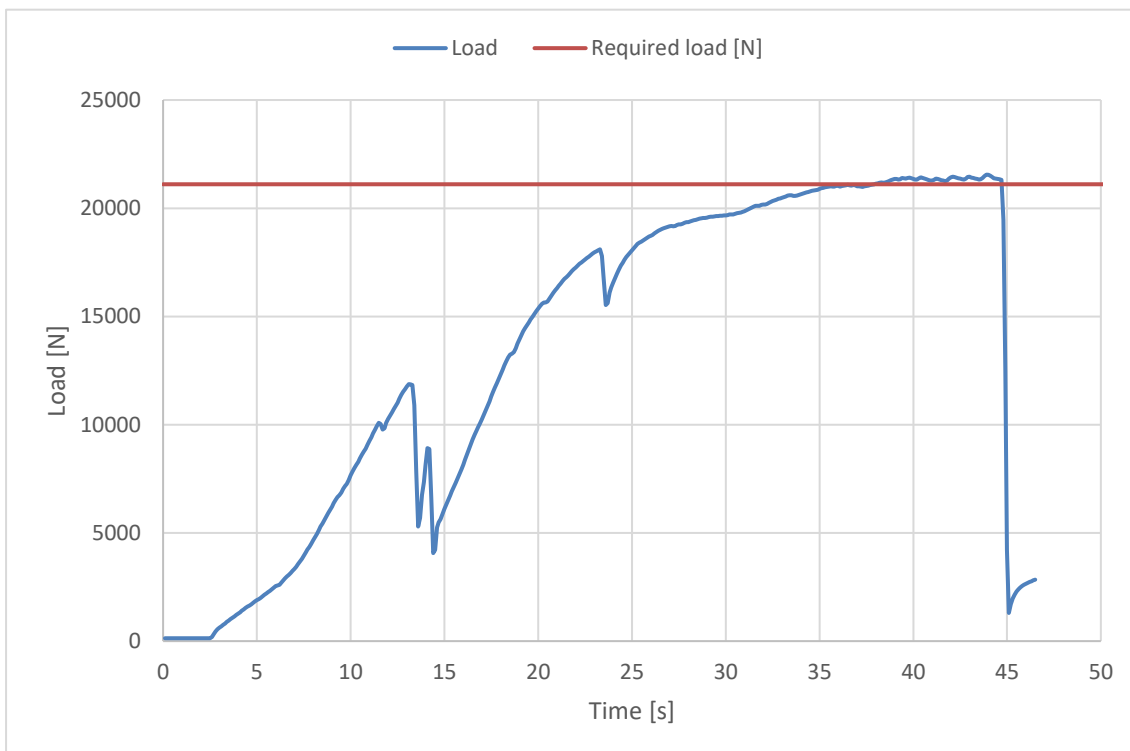

The validation of this test report is given by the signature of the test manager on the Inspection Certificate no 94.20b

Inspection certificate number: **PH\_366.2022**

model: **Halo**

**Harness Structural test**

**Test ID 12**

Standard	<b>EN 1651</b>
Reference in standard	<b>5.5.1.7</b>
Test setup	<b>Upright (landing) position load</b>
Attachment points	<b>Both main riser attachment (3, 4)</b>
Anchor points	<b>Both legstrap of harness (no dummy)</b>
Required load [g]	<b>6</b>
Required load [N]	<b>8400</b>
Minimum test duration [s]	<b>5</b>
Harness type	<b>type a</b>
<b>Result</b>	
Test duration [s]	<b>9.3</b>
Any signs of structural failure	<b>No</b>
Slippery test OK	<b>Yes</b>
Test results	<b>POSITIVE</b>

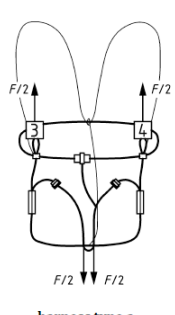
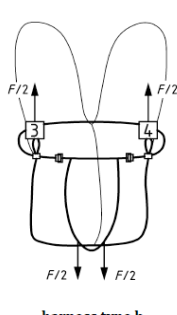
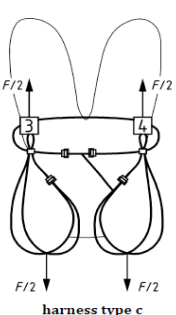

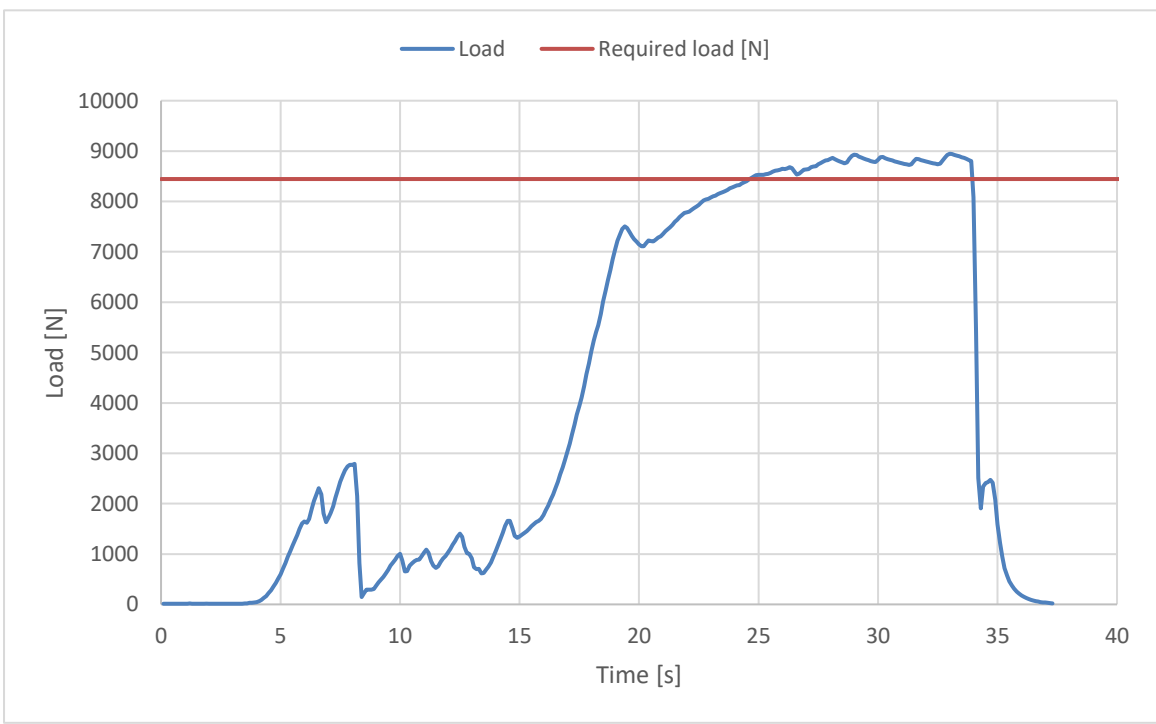
The validation of this test report is given by the signature of the test manager on the Inspection Certificate no 94.20b



Inspection certificate number: **PH\_366.2022**

model: **Halo**

**Rescue Deployment Test**

**Test ID RRDT**

Standard	<b>EN 1651</b>
Reference in standard	<b>5.5.1.11</b>
Test setup	<b>Default flying position</b>
Attachment points	<b>Sensor connect to handle, and pull in opening direction</b>
	The test is to simulate the load required to open the emergency parachute(1st action).
Min. Required load [N]	<b>20</b>
Max. Required load [N]	<b>70</b>
<b>Result</b>	
Load for first action [N]	<b>43.29</b>
Test results	<b>POSITIVE</b>

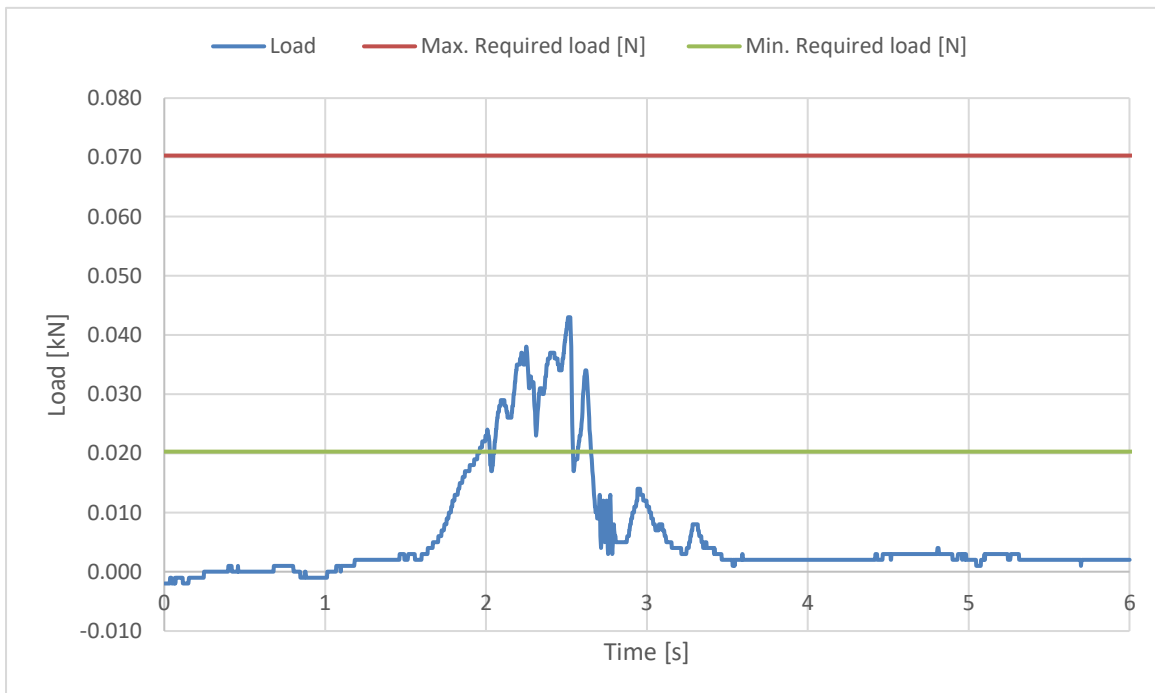

The validation of this test report is given by the signature of the test manager on the Inspection Certificate no 94.20b

Inspection certificate number: **PH\_366.2022**

model: **Halo**

**Rescue Deployment Handle strength test**

**Test ID RRST**

Standard	<b>EN 12491</b>
Reference in standard	<b>5.3.2</b>
Test setup	<b>Two end points of handle</b>
Attachment points	<b>Sensor connect to end of handle, pull on the other side</b>
	The handle must support min 700 N for 10 s, after measure breaking strength
Min. Required load [N]	<b>700</b>
Minimum test duration [s]	<b>10</b>
<b>Result</b>	
Test duration [s]:	<b>15.0</b>
Breaking strength [N]	<b>1389.71</b>
Test results	<b>POSITIVE</b>

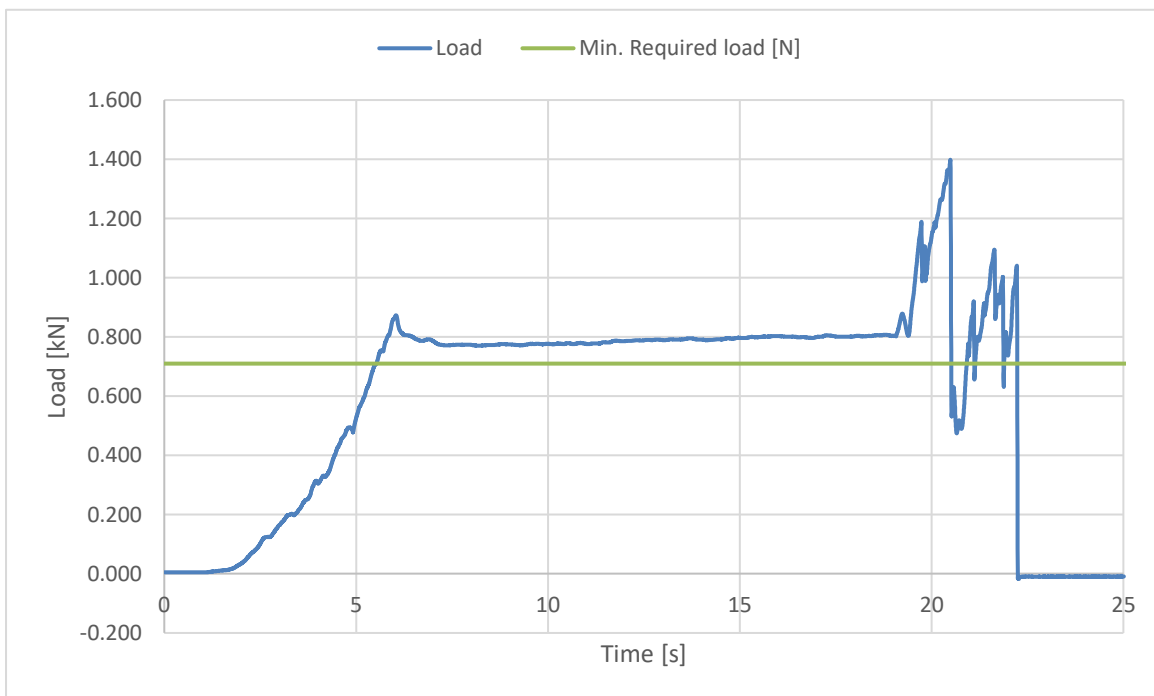

The validation of this test report is given by the signature of the test manager on the Inspection Certificate no 94.20b