

Harness Structural test Report - EN

Inspection certificate number: **PH_421.2023**
Manufacturer data:

Manufacturer name: **Nova Vertriebsgesellschaft m.b.H.**
 Representative: **Philipp Medicus**
 Street: **Auweg 14**
 Post code place: **6124 Terfens**
 Country: **Austria**

Sample data:

Name: **ARTUS**
 Type: **ABS**
 Size: **M**
 Serial number: **AR12001**
 Impact pad type: ⁽¹⁾ **Aluminium**
 Clip-in weight [kg]: **100**
 Date of test: **11.05.2023**

Atmosphere AGL:

| | |
|--------|-------------|
| [C°] | 20 |
| RH [%] | 28 |
| [hPa] | 1020 |

Summary of Structural test

| Test id | - EN 1651 | Setup | Req. Load | | Min. duration [s] | Result |
|----------------------|------------|---------------------------------------|-----------|---------------|-------------------|-----------------|
| | | | [g] | Req. Load [N] | | |
| 01 ⁽³⁾ | ✓ 5.5.1.1 | Positive symmetric load (Slippage) | 4.5 | 4500 | 5 | POSITIVE |
| 03 ⁽³⁾ | ✓ 5.5.1.1b | Positive symmetric load | 15 | 15000 | 5 | POSITIVE |
| 05 | ✓ 5.5.1.2 | Positive asymmetric load | 6 | 6000 | 5 | POSITIVE |
| 06 | ✓ 5.5.1.6 | Negative symmetric load | 6 | 6000 | 5 | POSITIVE |
| 08 ⁽⁵⁾ | ✓ 5.5.1.9 | Anti falling-out system | 4.5 | 4500 | 5 | POSITIVE |
| 09 ⁽³⁾⁽⁴⁾ | ✓ 5.5.1.3 | Positive symmetric load rescue points | 15 | 15000 | 5 | POSITIVE |
| 10 ⁽³⁾⁽⁴⁾ | 5.5.1.4 | Negative symmetric load rescue points | 15 | 15000 | 5 | n/a |
| 11 | 5.5.1.8 | Connecting element for rescue | n/a | 24000 | 0.3 | n/a |
| 12 ⁽³⁾ | ✓ 5.5.1.7 | Upright (landing) position load | 6 | 6000 | 5 | POSITIVE |
| 14 | 5.5.1.5 | Negative symmetric load towing points | 5 | 5000 | 5 | n/a |

Rescue deployment test

| Test id | - NfL II 91/09 | Setup | Min load | | Measured [N] | Result |
|---------|----------------|-------------------------|----------|---------------|--------------|-----------------|
| | | | [N] | Max. load [N] | | |
| RRDT | ✓ 6.1.5 | Default flying position | 20 | 70 | 48.67 | POSITIVE |

Rescue Deployment Handle strength test

| Test id | - EN 12491 | Setup | Req. Load [N] | Min. duration [s] | Breaking strength [N] | Result |
|---------|------------|--------------------------|---------------|-------------------|-----------------------|-----------------|
| RRST | ✓ 5.3.2 | Two end points of handle | 700 | 10 | 968.52 | POSITIVE |

| Manufacturer | Instrument | Type no | S/N | Validity |
|---------------|----------------------|--------------------|----------|------------|
| HBM | Load Sensor GE01 | 1-S9M/50KN-1 | 31314643 | 04.09.2023 |
| Burster / MTS | Load sensor 10kN SL2 | 8431-6010-N000S000 | 593507 | 21.04.2026 |
| JDC elec | Geos n°11 Skywatch | Geos n°11 | Unit11 | 18.06.2025 |

Air Turquoise SA, having thoroughly assessed the sample mentioned above, declare it was found conform with
 European Standard **EN1651:2018+A1:2020**, and **EN12491:2015+A1:2021**

The validation of this test report is given by the signature of the test manager on the Inspection Certificate no 94.20

(1) If Impact pad available, see test report no. 94.22 and inspection certificate no. 94.20. ⁽³⁾ Slipping test of any adjustable components: No slippage of any adjustable element more than 10 mm at 4500N for 5 s. The marks should be added with a pre-load of 1000N. ⁽⁴⁾ For harness with integrated Y bridle, test in the end loop ⁽⁵⁾ Attach to anti-falling out system without connecting the crotch straps (breast straps)

Calculated value in tests reports include the value minus the uncertainty (on safe side) / The uncertainty stated is the expanded uncertainty obtained by multiplying the standard uncertainty by the coverage factor k = 2. The value of the measurand lies within the assigned range of values with a probability of 95%.

This declaration must not be reproduced in part without the written permission of AIR TURQUOISE SA.

Inspection certificate number: **PH_421.2023**

model: **ARTUS**

Harness Structural test

Test ID 01

Standard **EN 1651**
 Reference in standard **5.5.1.1**
 Test setup **Positive symmetric load (Slippage)**
 Attachment points **Both main riser attachment (3,4)**
 Anchor points **Dummy (B1, B2)**

Required load [g] **4.5**
 Required load [N] **4500**
 Minimum test duration [s] **5**

Result

Test duration [s] **30.4**
 Any signs of structural failure **No**
 Slippery test OK **Yes**
 Test results **POSITIVE**

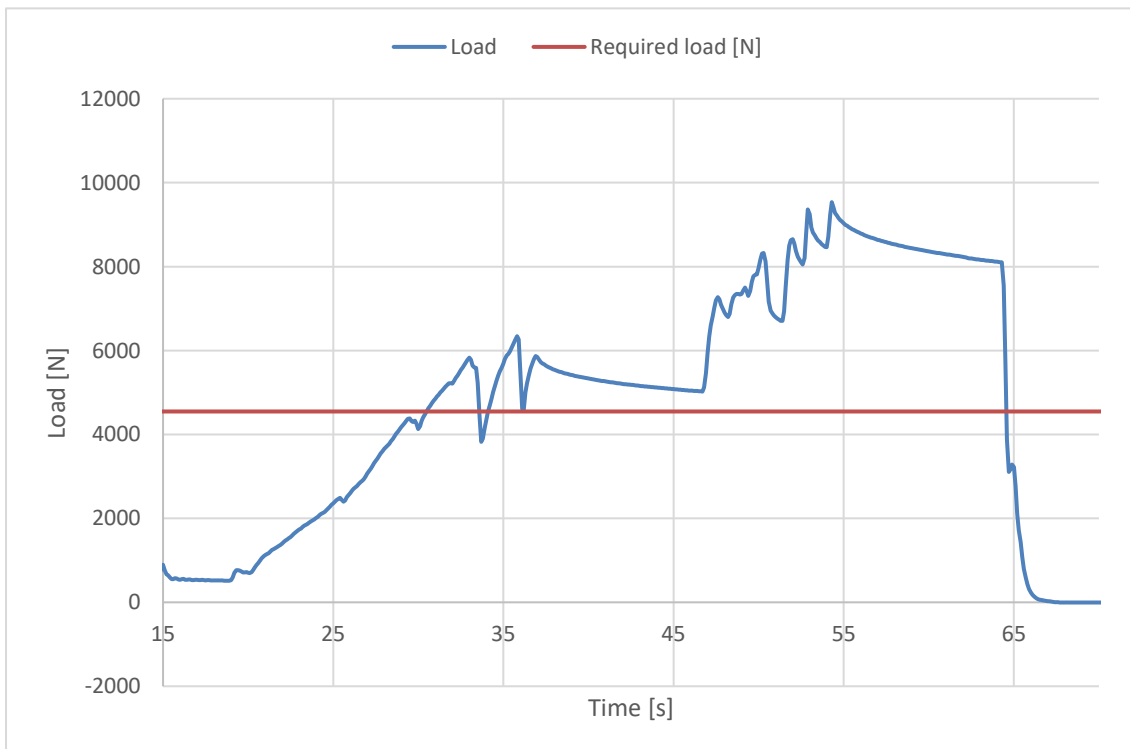
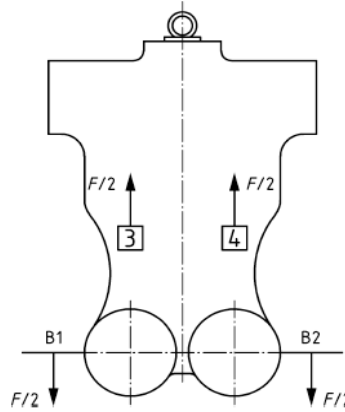

The validation of this test report is given by the signature of the test manager on the Inspection Certificate no 94.20

Inspection certificate number: **PH_421.2023**

model: **ARTUS**

Harness Structural test

Test ID 03

Standard **EN 1651**
 Reference in standard **5.5.1.1b**
 Test setup **Positive symmetric load**
 Attachment points **Both main riser attachment (3,4)**
 Anchor points **Dummy (B1, B2)**

Required load [g] **15**
 Required load [N] **15000**
 Minimum test duration [s] **5**

Result

Test duration [s] **7**
 Any signs of structural failure **No**
 Slippery test OK **Yes**
 Test results **POSITIVE**

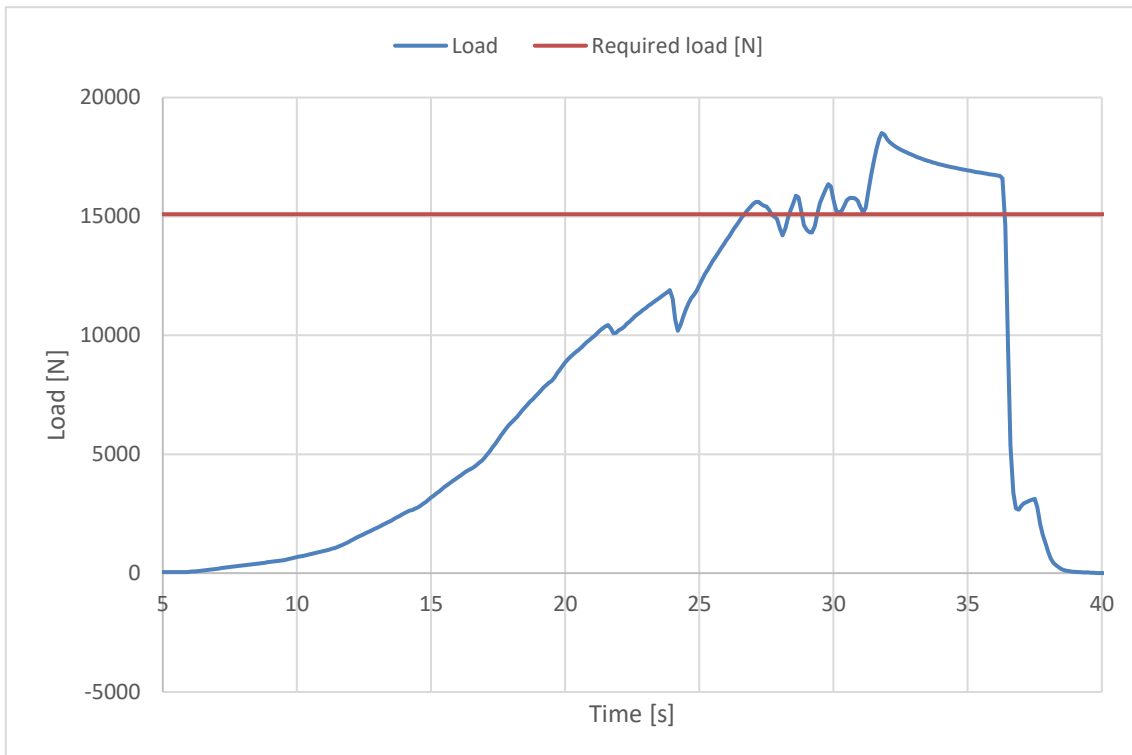
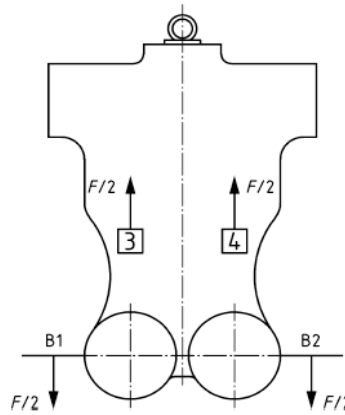

The validation of this test report is given by the signature of the test manager on the Inspection Certificate no 94.20

Inspection certificate number: **PH_421.2023**

model: **ARTUS**

Harness Structural test

Test ID 05

| | |
|---------------------------------|--------------------------------------|
| Standard | EN 1651 |
| Reference in standard | 5.5.1.2 |
| Test setup | Positive asymmetric load |
| Attachment points | One riser attachment (3 or 4) |
| Anchor points | Dummy (C) |
| Required load [g] | 6 |
| Required load [N] | 6000 |
| Minimum test duration [s] | 5 |
| Result | |
| Test duration [s] | 17.3 |
| Any signs of structural failure | No |
| Test results | POSITIVE |

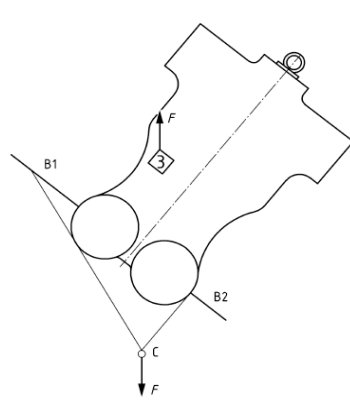
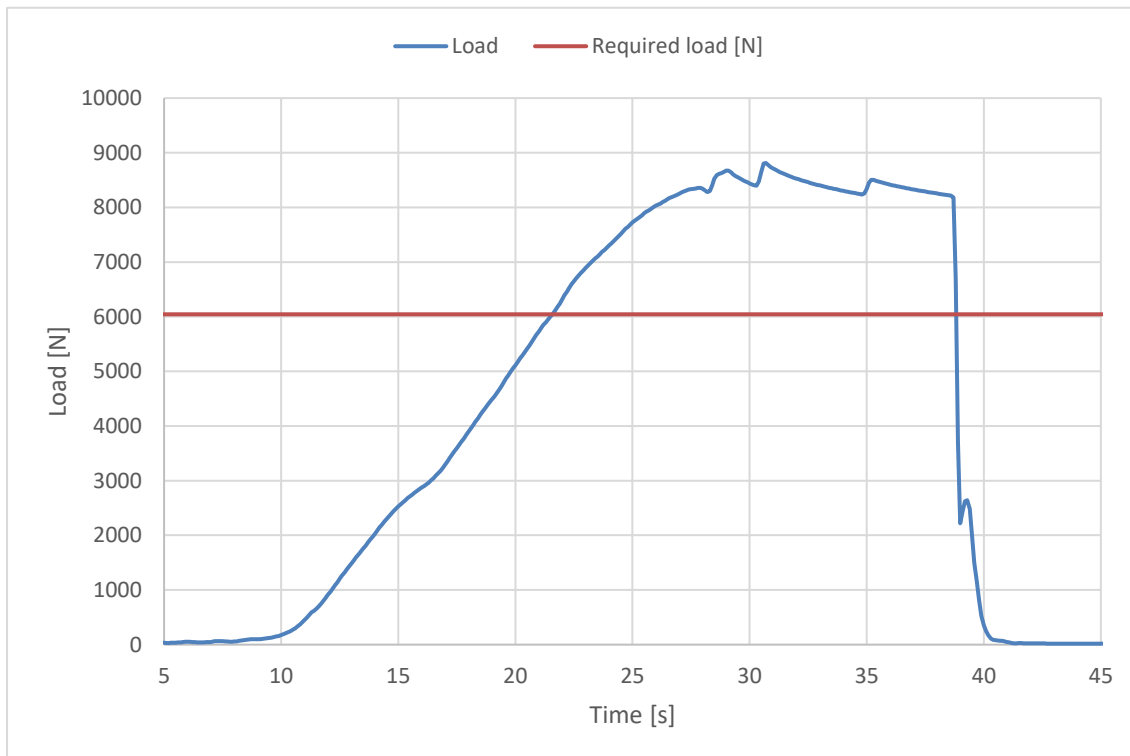
The validation of this test report is given by the signature of the test manager on the Inspection Certificate no 94.20

Inspection certificate number: **PH_421.2023**

model: **ARTUS**

Harness Structural test

Test ID 06

| | |
|---------------------------------|---|
| Standard | EN 1651 |
| Reference in standard | 5.5.1.6 |
| Test setup | Negative symmetric load |
| Attachment points | Both main riser attachment (3,4) |
| Anchor points | Dummy (A) |
| Required load [g] | 6 |
| Required load [N] | 6000 |
| Minimum test duration [s] | 5 |
| Result | |
| Test duration [s] | 7.1 |
| Any signs of structural failure | No |
| Test results | POSITIVE |

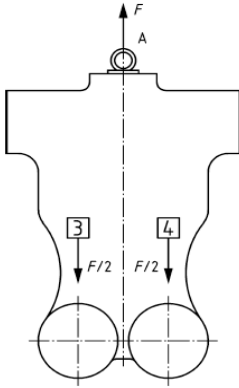
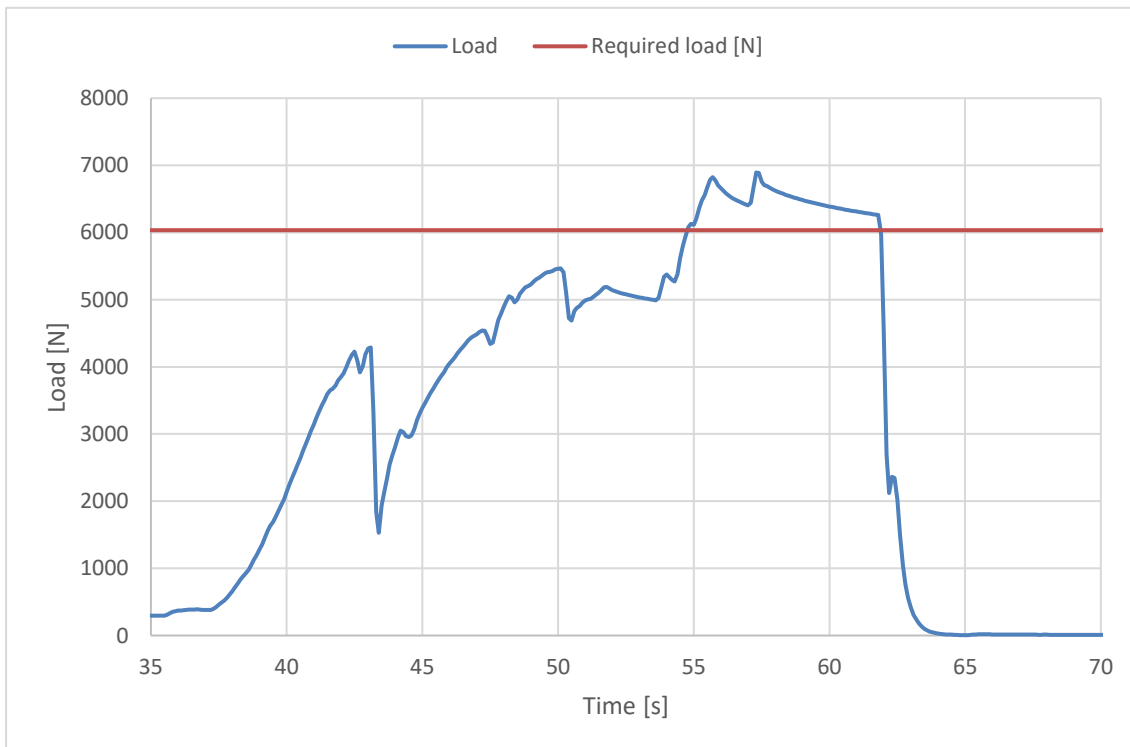
The validation of this test report is given by the signature of the test manager on the Inspection Certificate no 94.20

Inspection certificate number: **PH_421.2023**

model: **ARTUS**

Harness Structural test

Test ID 08

| | |
|---------------------------------|--|
| Standard | EN 1651 |
| Reference in standard | 5.5.1.9 |
| Test setup | Anti falling-out system |
| Attachment points | Around anti falling-out system |
| Anchor points | Both main riser attachment (no dummy) |
| Required load [g] | 4.5 |
| Required load [N] | 4500 |
| Minimum test duration [s] | 5 |
| Result | |
| Test duration [s] | 8.9 |
| Any signs of structural failure | No |
| Test results | POSITIVE |

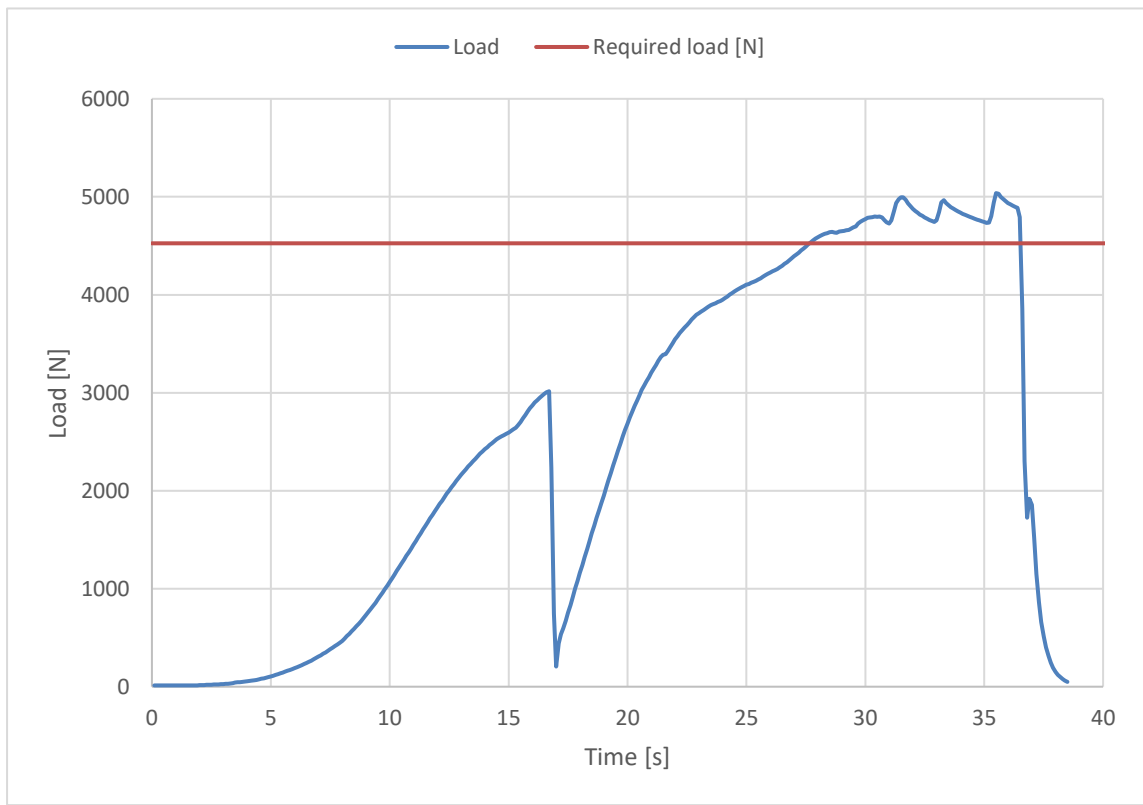

The validation of this test report is given by the signature of the test manager on the Inspection Certificate no 94.20

Inspection certificate number: **PH_421.2023**

model: **ARTUS**

Harness Structural test

Test ID 09

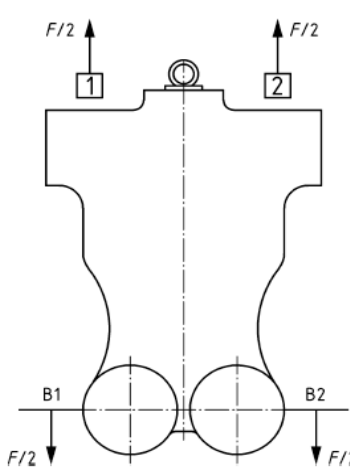
| | | |
|---------------------------------|--|--|
| Standard | EN 1651 |  |
| Reference in standard | 5.5.1.3 | |
| Test setup | Positive symmetric load rescue points | |
| Attachment points | Both main riser attachment (1,2) | |
| Anchor points | Dummy (B1,B2) | |
| Required load [g] | 15 | |
| Required load [N] | 15000 | |
| Minimum test duration [s] | 5 | |
| Result | | |
| Test duration [s] | 10.3 | |
| Any signs of structural failure | No | |
| Slippery test OK | Yes | |
| Test results | POSITIVE | |

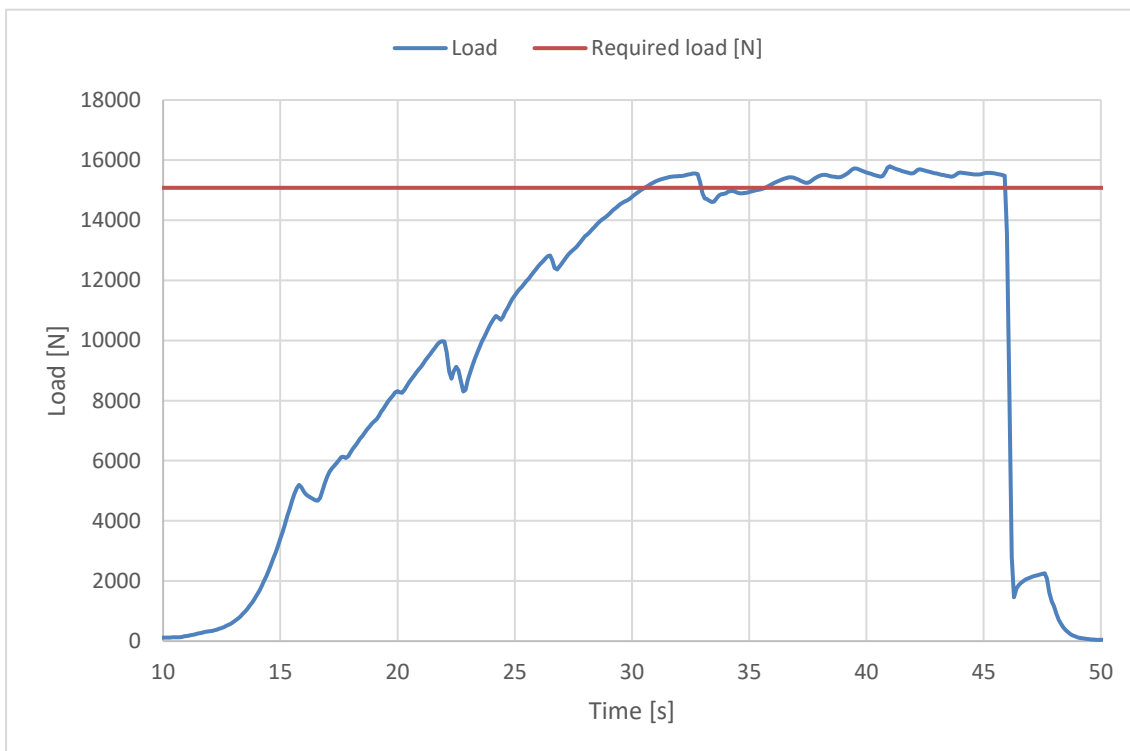

The validation of this test report is given by the signature of the test manager on the Inspection Certificate no 94.20

Inspection certificate number: **PH_421.2023**

model: **ARTUS**

Harness Structural test

Test ID 12

| | |
|---------------------------------|--|
| Standard | EN 1651 |
| Reference in standard | 5.5.1.7 |
| Test setup | Upright (landing) position load |
| Attachment points | Both main riser attachment (3, 4) |
| Anchor points | Both legstrap of harness (no dummy) |
| Required load [g] | 6 |
| Required load [N] | 6000 |
| Minimum test duration [s] | 5 |
| Harness type | type b |
| Result | |
| Test duration [s] | 8.7 |
| Any signs of structural failure | No |
| Slippery test OK | Yes |
| Test results | POSITIVE |

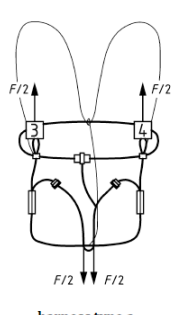
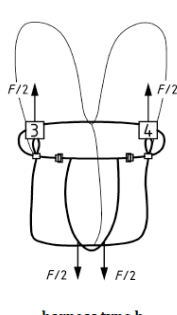
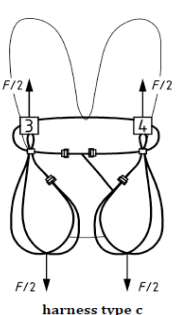

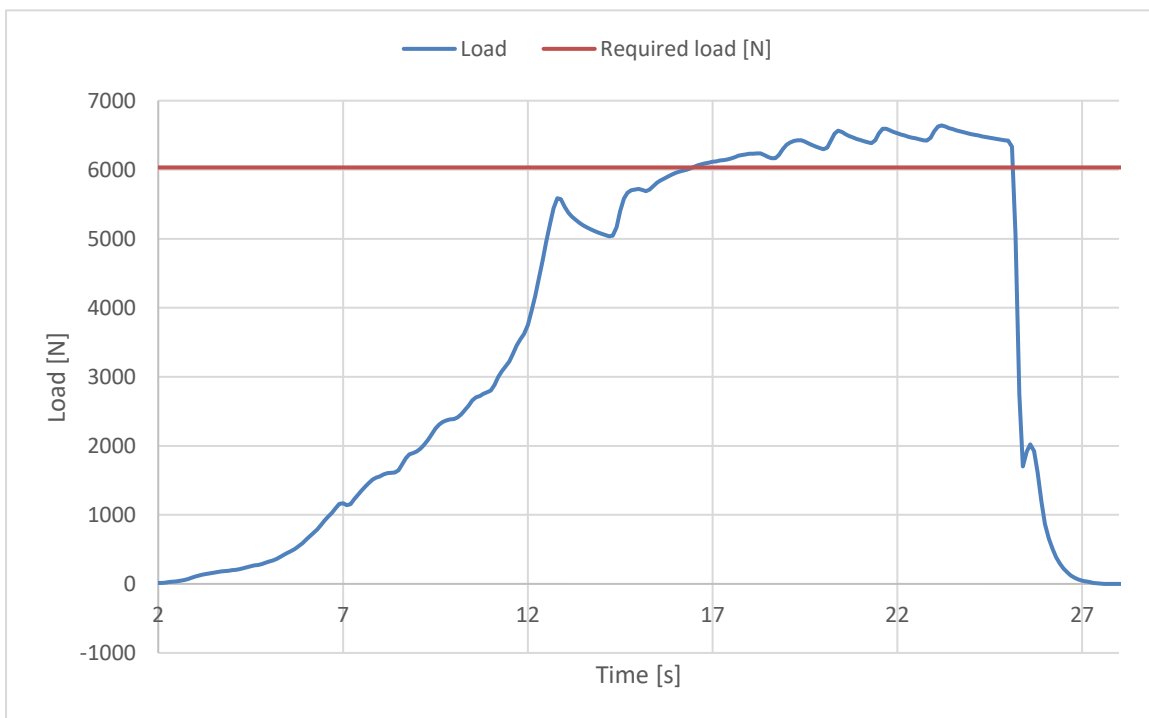
The validation of this test report is given by the signature of the test manager on the Inspection Certificate no 94.20

Inspection certificate number: **PH_421.2023**

model: **ARTUS**

Rescue Deployment Test

Test ID RRDT

| | |
|-----------------------|--|
| Standard | EN 1651 |
| Reference in standard | 5.5.1.11 |
| Test setup | Default flying position |
| Attachment points | Sensor connect to handle, and pull in opening direction |

The test is to simulate the load required to open the emergency parachute(1st action).

| | |
|------------------------|-----------|
| Min. Required load [N] | 20 |
| Max. Required load [N] | 70 |

Result

| | |
|---------------------------|-----------------|
| Load for first action [N] | 48.67 |
| Test results | POSITIVE |

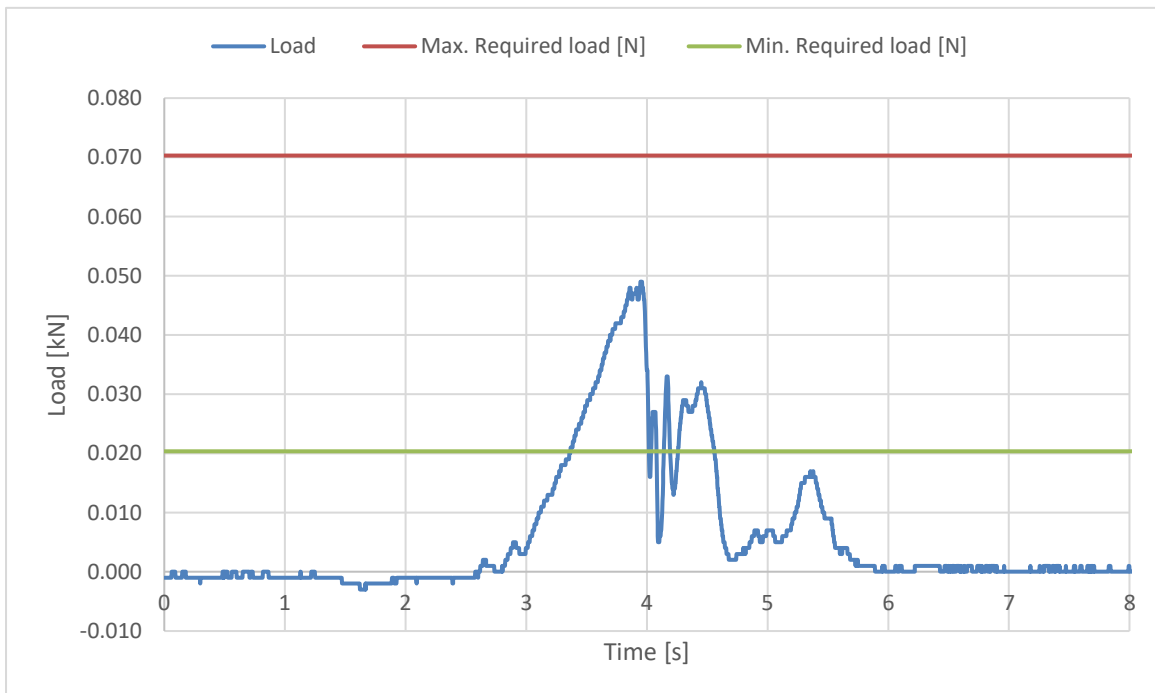

The validation of this test report is given by the signature of the test manager on the Inspection Certificate no 94.20

Inspection certificate number: **PH_421.2023**

model: **ARTUS**

Rescue Deployment Handle strength test

Test ID RRST

| | |
|---------------------------|---|
| Standard | EN12491 |
| Reference in standard | 5.3.2 |
| Test setup | Two end points of handle |
| Attachment points | Sensor connect to end of handle, pull on the other side |
| | The handle must support min 700 N for 10 s, after measure breaking strength |
| Min. Required load [N] | 700 |
| Minimum test duration [s] | 10 |
| Result | |
| Test duration [s]: | 13.5 |
| Breaking strength [N] | 968.52 |
| Test results | POSITIVE |

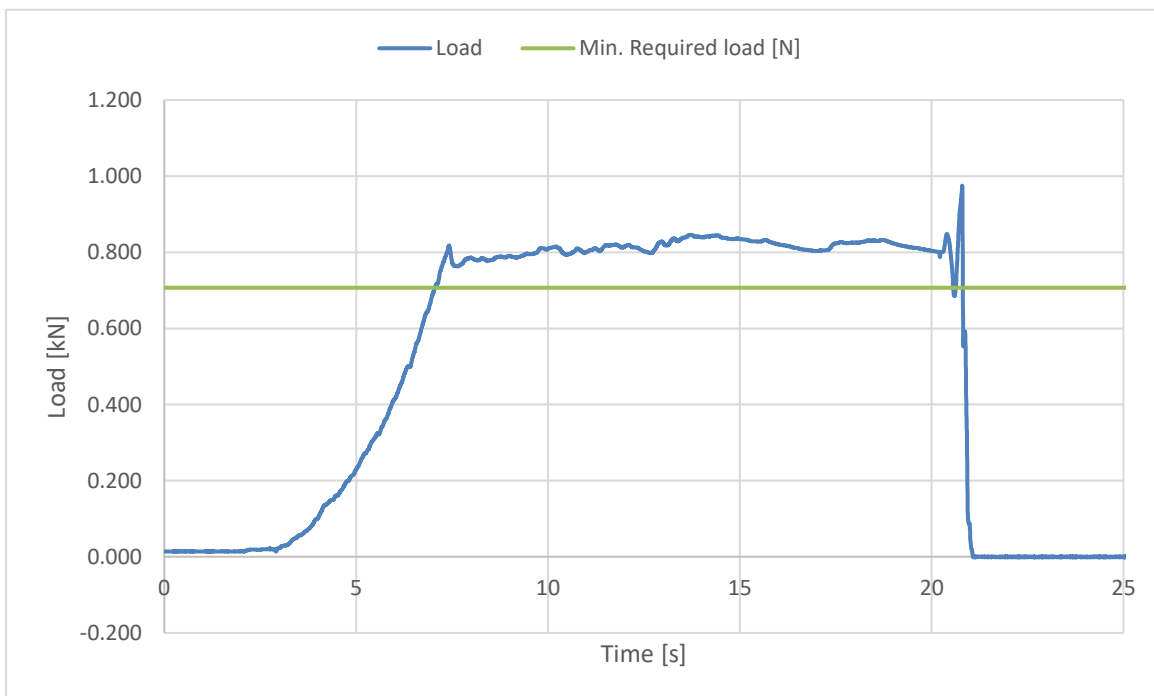

The validation of this test report is given by the signature of the test manager on the Inspection Certificate no 94.20