



## Test Report

This test report describes the test results of the below mentioned paragliding harness.

All the tests were carried out by:

Air Turquoise SA, official test laboratory of Switzerland.

para-test.com



paragliding by air turquoise

## Standards

Tests were carried out in conformity with the following standards:

- 2. DV LuftGerPV §1, Nr. 7 c (\*note: in what follows this will be abbreviated by "LTF")
- European Standard EN1651 September 1999 (\*note in what follows this will be abbreviated by "EN")
- European Standard EN12491 September 2001 (\*note in what follows this will be abbreviated by "EN12491")

## Harness details

<b>Manufacturer:</b>	KARPO FLY s.r.o.
<b>Harness model:</b>	Reflex 2
<b>Size:</b>	All
<b>Harness Weight:</b>	3.1 kg
<b>Maximum certified pilot</b>	120 kg
<b>Impact protection type:</b>	Foam protector
<b>Harness type:</b>	ABS

<b>Test responsible:</b>	Alain Zoller
<b>Test place:</b>	Villeneuve
<b>Test date:</b>	March 20, 2013
<b>Test room temp &amp; humidity:</b>	24,6°C; 29 %rel
<b>Certification number EN:</b>	PH 086.2013
<b>Certification number LTF:</b>	GZ 086.2013

page 1 of 4

Air Turquoise SA certified by



**Air Turquoise S.A. - Certification of paraglider equipment**  
 Tested in accordance with EN 1651:1999 and 2.DV LuftGerPV§1, Nr.7c

Prepared by RE  
 Rev.0, 25.01.2011  
 No. 71.9.3



## Test summary

### A. STRUCTURAL STRENGTH TESTS

A test plan was set up in order to execute the different tests in an efficient order. The table below summarizes this test plan together with the applicable standards and results.

Test ID	TESTED ?	Standard Ref.		TEST setup	Anchoring		Forces		Min. Test duration [sec]	Result
		EN	LTF		Attach - ment points	Dummy	Req. Load in g	Min. force [N]		
1	✓	5.3.2.1		Default flying position	2 main attachment points	Hip fixated	6g	6000	10	OK
2	✓		4.2.1.a				9g	9000		
3	✓			Default, landing position	2 main att. points	Hip fixated, landing conf.	6g	6000	10	OK
4	✓	5.3.2.7					15g	15000		
5	✓		4.2.1.a rescue	Rescue	2 rescue att. Pnts.	Hip fixated	9g	9000	10	OK
6	✓	5.3.2.4					15g	15000		
7	✓		4.2.1.b rescue	Rescue, landing		Hip fixated, landing conf.	6g	6000	10	OK
8	✓	5.3.2.3		One riser	ONE main att.	1 central hip fixation	6g	6000	10	OK
9			4.2.1.d	Towing	2 main att. + 2 tow att.	None	3g	3000	10	n/a
		5.3.2.5					5g	5000		
10	✓	5.3.2.6		Default, Negatif	One main att.	Head fix.	4.5g	4500	10	OK
11	✓		4.2.1.c	Upside down	2 main att. downw.	Head fix.	6g	6000	10	OK
12	✓		4.2.1.c rescue	Upside down rescue	2 rescue att. downw.		6g	6000	10	OK

### B. HARNESS PROTECTION SHOCK TEST

Most paraglider harnesses are equipped with a protection device that damps the shock on the pilot's spine during a hard landing.

Shock impact tests have to be executed on these harnesses in order to prove the damping characteristics of it.



Test ID	TESTED ?	Standar d Ref.:	TEST setup	Anchoring		Impact			Result		
		LTF		Attach- ment points	Dummy	Max. tolerated peak impact in g	Max Peak impact measured	Impact duration of + 38 g (if any) recorded:		Impact duration of + 20 g (if any) recorded:	
<b>PRO TECT 1</b>	✓	5.1.1	<b>Default flying position</b>	Test dummy is attached to the harness like a pilot in flight.			+50g	34.05 g	0	14 ms	<b>OK</b>

### C. RESCUE DEPLOYMENT RESISTANCE TEST

The deployment of the rescue system has to be ensured in all circumstances of flight. This test is to verify whether the force needed to deploy is in between reasonable limits.

Test ID	TESTED ?	Standar d Ref.	TEST setup	Anchoring		Force for single hand deployment			Result	
		LTF		Attach- ment points	Dummy	Min. force [N]	max. force [N]	Resistance measured [daN]		
<b>Resc depl</b>	✓	6.1.5	<b>Default flying position</b>	Test responsible is attached to the harness like a pilot in flight. (no dummy required)			20 N	70 N	n/t	<b>OK</b>

### D. RESCUE DEPLOYMENT STRAP STRENGTH TEST

The connection between handgrip and inner container has to have sufficient load capacity/structural strength in any situation that may arise during normal use. During this test is verified, whether this connection fulfill the requirements.

Test ID	TESTED ?	Standard Ref.		TEST setup	Minimum force [N]	Min. Test durati on [s]	Breaking resistance measured	Result
		LTF	EN 12491					
<b>Resc strap</b>	✓	6.1.8	5.3.2	Connection strap in tensile testing machine	700N	10	n/t	<b>OK</b>



After careful examination as explained in above mentioned test reports (from page 2 to page 18), the undersigned persons declare that the harness:

**KARPO FLY s.r.o.**  
**Reflex 2**  
**All**

Complied with:

- **European Standard EN 1651 September 1999**

And / or (if tested)

- **European Standard EN 12491 March 2001**

And / or (if tested)

- **2. DV LuftGerPV §1, Nr. 7 c**

Villeneuve, March 20, 2013

Place, Date

  
EN & LTF Testing center  
Alain Zoller  
  
www.para-test.com  
Test responsible

page 4 of 4



Annex: detailed test reports

**Harness Test**

**Test ID 1**

**Item:** Reflex 2  
**Manufacturer:** KARPO FLY s.r.o.  
**Test place & date:** Villeneuve March 20, 2013  
**Test responsible:** Alain Zoller  
**Temp. [°C] & Humidity:** 24,6°C; 29 %rel  
**Maximum certified pilot weight [kg]:** 120 kg

**Standard:** EN 1651 & 2. DV LuftGerPV §1, Nr. 7 c  
**Test standard §:** 5.3.2.1 (EN) & 4.2.1 a (LTF DV)

**Test setup:** Default flying position  
**Anchoring: Attachment points:** Both main riser attachments (3, 4)  
**Dummy:** Default, hip fixed (7, 8)

**Required load in g :** 9g (EN: 6g)  
**Minimum load [N]:** 9000 N (EN: 6000 N)  
**Required test load in kg:** **1080 kg**  
**Min. duration [s]:** 10 s

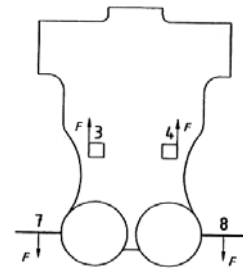

**Results**

**Duration of maintained min. load [s]:** **11.1 s**

**Any signs of structural failure after this test:** **No visible failure**

**Test result:** **Passed**

**Graph:**

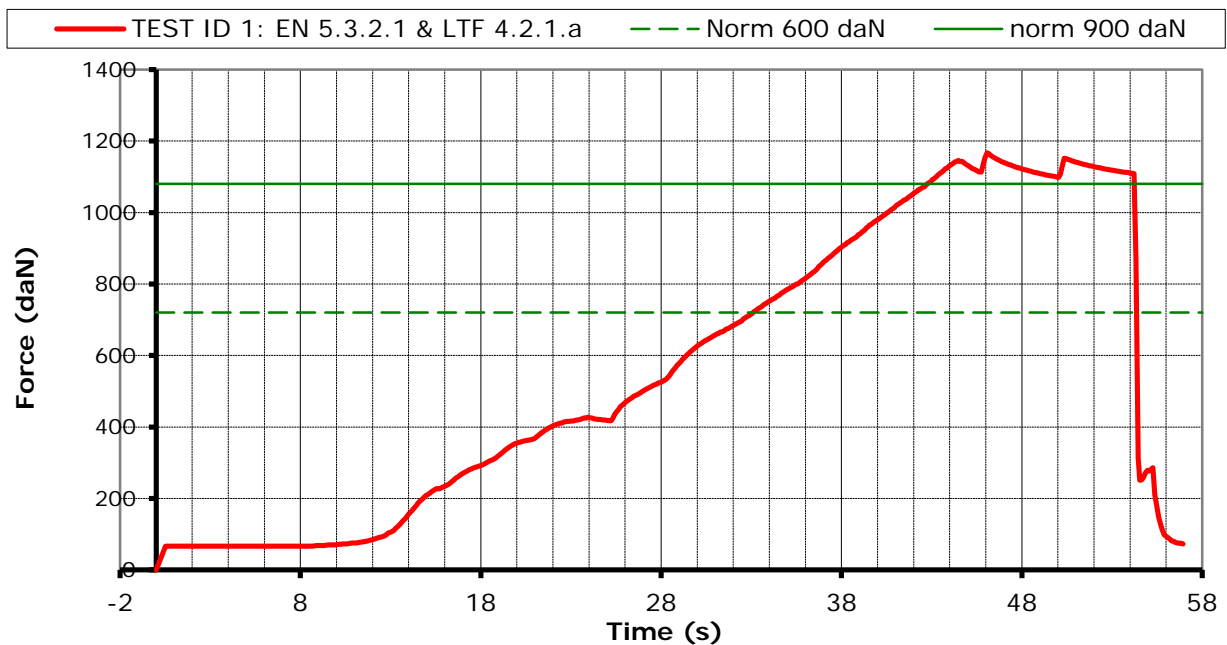

Air Turquoise SA certified by



**Air Turquoise S.A. - Certification of paraglider equipment**  
 Tested in accordance with EN 1651:1999 and 2.DV LuftGerPV§1, Nr.7c

Annex TEST ID 1  
 Prepared by RE  
 Rev.0, 25.01.2011  
 No. 71.9.3



**Harness Test**

**Test ID 2**

**Item:** Reflex 2  
**Manufacturer:** KARPO FLY s.r.o.  
**Test place & date:** Villeneuve March 20, 2013  
**Test responsible:** Alain Zoller  
**Temp. [°C] & Humidity:** 24,6°C; 29 %rel  
**Maximum certified pilot weight [kg]:** 120 kg

**Standard:** EN 1651

**Test standard §:** 5.3.2.2

**Test setup:** Default flying position

**Anchoring: Attachment points:** Both main riser attachments (3, 4)

**Dummy:** Default, hip fixed (7, 8)

**Required load in g:** 15 g

**Min load [N]:** 15 000 N

**Required test load in kg:** **1800 kg**

**Min. duration [s]:** 5s

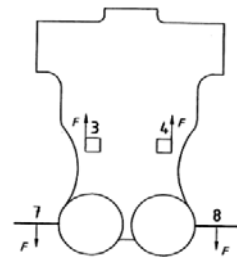

**Results**

**Duration of maintained min. load [s]:** **6.7 s**

**Any signs of structural failure after this test:** **No visible failure**

**Test result:** **Passed**

**Graph:**

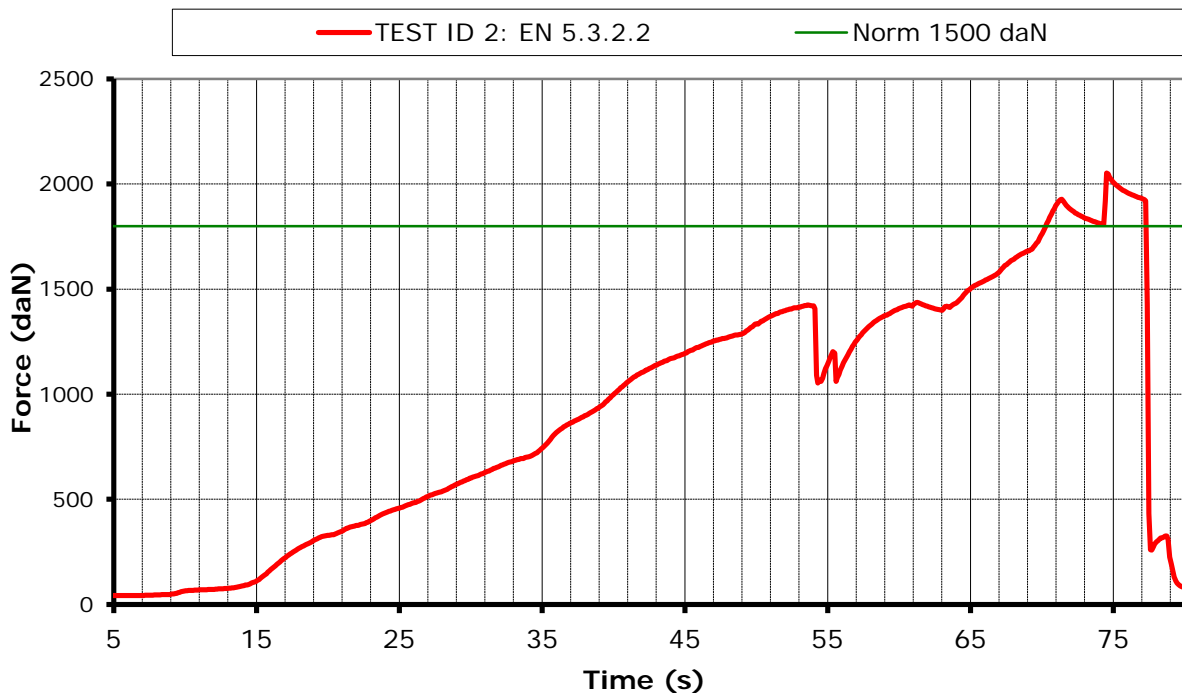

Air Turquoise SA certified by



**Air Turquoise S.A. - Certification of paraglider equipment**  
 Tested in accordance with EN 1651:1999 and 2.DV LuftGerPV§1, Nr.7c

Annex TEST ID 2  
 Prepared by RE  
 Rev.0, 25.01.2011  
 No. 71.9.3





## Harness Test

## Test ID 3

Item: Reflex 2  
 Manufacturer: KARPO FLY s.r.o.  
 Test place & date: Villeneuve March 20, 2013  
 Test responsible: Alain Zoller  
 Temp. [°C] & Humidity: 24,6°C; 29 %rel  
 Maximum certified pilot weight [kg]: 120 kg

Standard: 2. DV LuftGerPV §1, Nr. 7 c

Test standard §: 4.2.1.b

Test setup: Flying position before landing: seat board (11) in landing position, leg straps (10) closed.

Anchoring: Attachment points: Both of the main riser attachments attached (3 and 4);

Dummy: Default, hip fixed (7, 8)

Required load in g: 6 g

Min load [N]: 6000 N

Required test load in kg: **720** kg

Min. duration [s]: 10 s

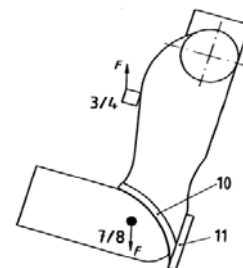

### Results

Duration of maintained min. load [s]: **11.2 s**

Any signs of structural failure after this test: **No visible failure**

Test result: **Passed**

### Graph:

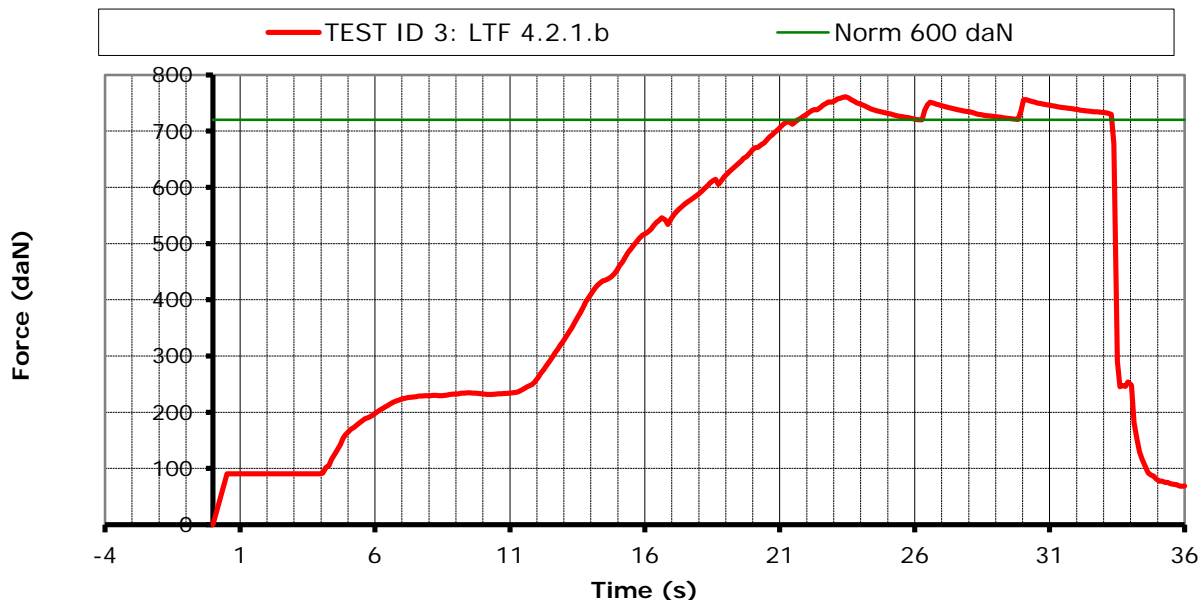

Air Turquoise SA certified by



**Air Turquoise S.A. - Certification of paraglider equipment**  
 Tested in accordance with EN 1651:1999 and 2.DV LuftGerPV§1, Nr.7c

Annex TEST ID 3  
 Prepared by RE  
 Rev.0, 25.01.2011  
 No. 71.9.3



## Harness Test

## Test ID 4

Item: Reflex 2  
 Manufacturer: KARPO FLY s.r.o.  
 Test place & date: Villeneuve March 20, 2013  
 Test responsible: Alain Zoller  
 Temp. [°C] & Humidity: 24,6°C; 29 %rel  
 Maximum certified pilot weight [kg]: 120 kg

Standard: EN 1651  
 Test standard §: EN 5.3.2.7

Test setup: Flying position before landing: seat board (11) in landing position, leg straps (10) closed.

Anchoring: Attachment points: Both of the main riser attachments attached (3 and 4);  
 Dummy: Default, hip fixed (7, 8)

Required load in g: 15 g  
 Min load [N]: 15 000 N  
 Required test load in kg: **1800 kg**  
 Min. duration [s]: 5 s

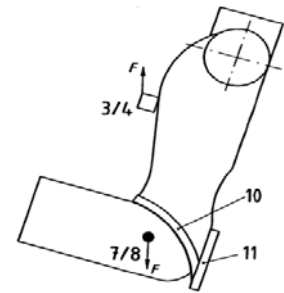

### Results

Duration of maintained min. load [s]: **6.3 s**

Any signs of structural failure after this test: **No visible failure**

Test result: **Passed**

### Graph:

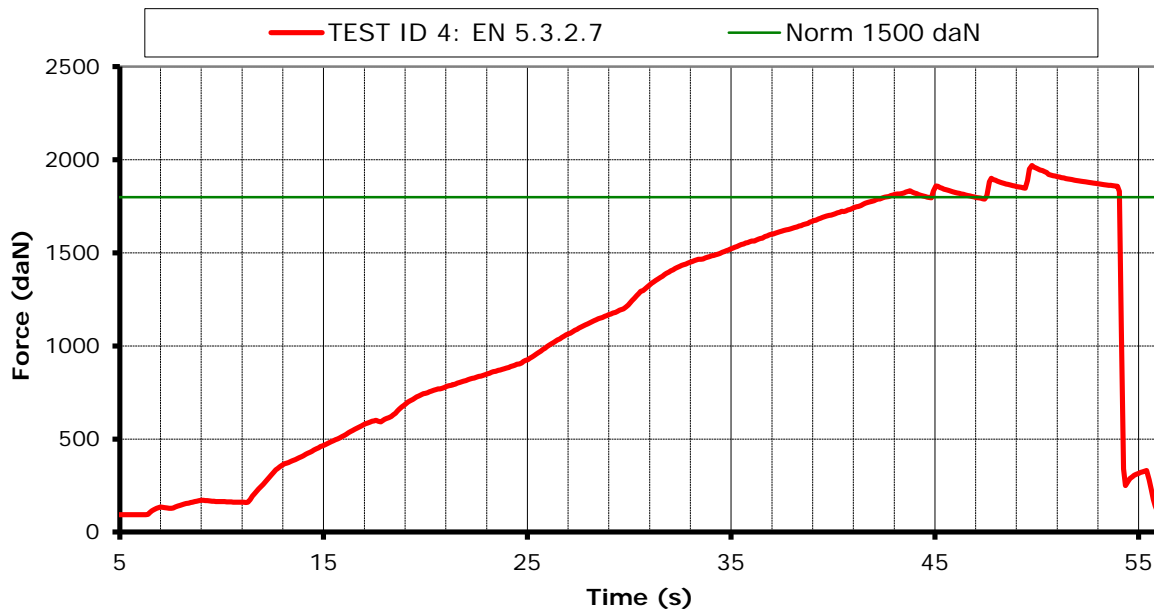

Air Turquoise SA certified by

ISO 9001  
BUREAU VERITAS  
Certification



Air Turquoise S.A. - Certification of paraglider equipment  
 Tested in accordance with EN 1651:1999 and 2.DV LuftGerPV§1, Nr.7c

Annex TEST ID 4  
 Prepared by RE  
 Rev.0, 25.01.2011  
 No. 71.9.3



**Harness Test**

**Test ID 5**

Item: Reflex 2  
 Manufacturer: KARPO FLY s.r.o.  
 Test place & date: Villeneuve March 20, 2013  
 Test responsible: Alain Zoller  
 Temp. [°C] & Humidity: 24,6°C; 29 %rel  
 Maximum certified pilot weight [kg]: 120 kg

Standard: 2. DV LuftGerPV §1, Nr. 7 c  
 Test standard §: 4.2.1.a rescue  
 Test setup: Rescue attachments  
 Anchoring: Attachment points: Rescue riser attachments (1,2)  
 Dummy: Hip fixed (7, 8)  
 Required load in g: 9 g  
 Min load [N]: 9 000 N  
 Required test load in kg: **1080 kg**  
 Min. duration [s]: 10 s

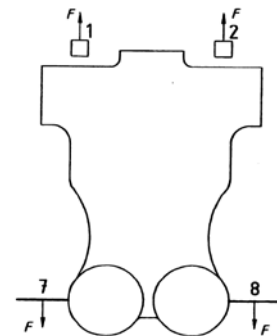

**Results**

Duration of maintained min. load [s]: **11.9 s**

Any signs of structural failure after this test: **No visible failure**

Test result: **Passed**

**Graph:**

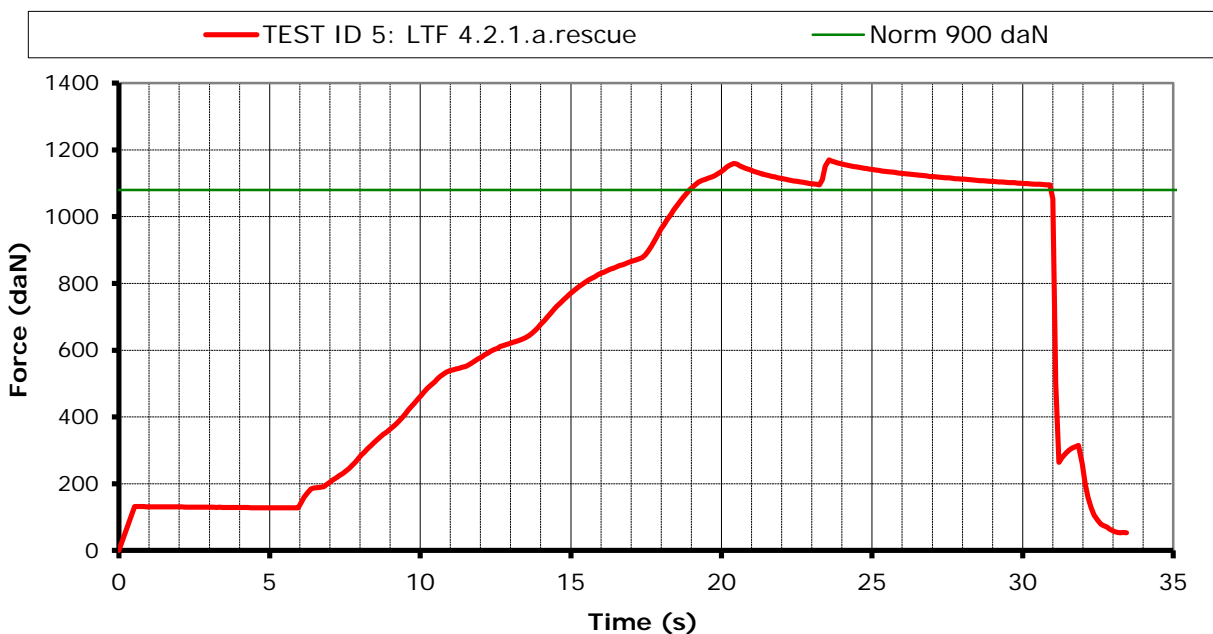

Air Turquoise SA certified by



**Air Turquoise S.A. - Certification of paraglider equipment**  
 Tested in accordance with EN 1651:1999 and 2.DV LuftGerPV§1, Nr.7c

Annex TEST ID 5  
 Prepared by RE  
 Rev.0, 25.01.2011  
 No. 71.9.3



## Harness Test

## Test ID 6

Item:	Reflex 2	
Manufacturer	KARPO FLY s.r.o.	
Test place & date:	Villeneuve	March 20, 2013
Test responsible:	Alain Zoller	
Temp. [°C] & Humidity:	24,6°C; 29 %rel	
Maximum certified pilot weight [kg]:	120	kg

Standard	EN 1651
Test standard §:	5.3.2.4
Test setup:	Rescue attachments

Anchoring: Attachment points: Rescue riser attachments (1,2)

Dummy: Hip fixed (7, 8)

Required load in g:	15	g
Min load [N]:	15 000	N
Required test load in kg:	1800	kg
Min. duration [s]:	5	s

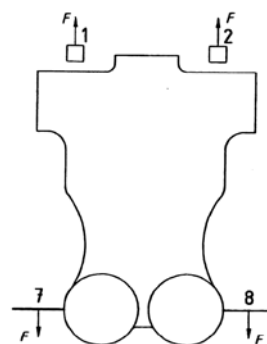

### Results

Duration of maintained min. load [s]: **6.2 s**

Any signs of structural failure after this test: **No visible failure**

Test result: **Passed**

### Graph:

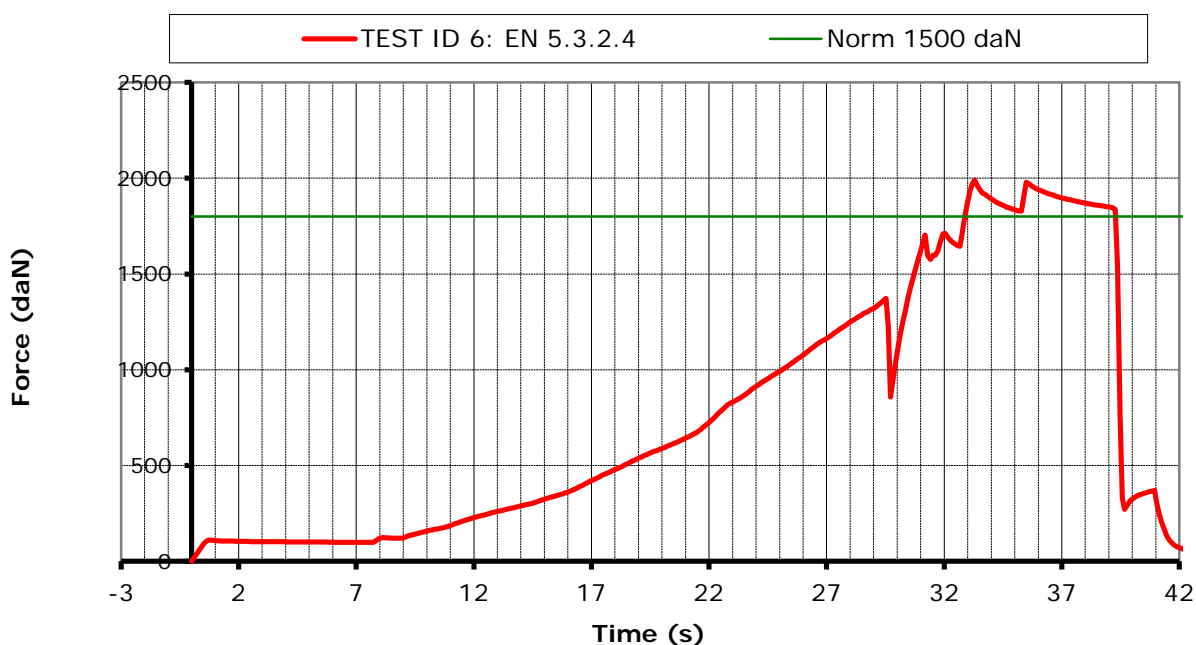

Air Turquoise SA certified by



**Air Turquoise S.A. - Certification of paraglider equipment**  
Tested in accordance with EN 1651:1999 and 2.DV LuftGerPV§1, Nr.7c

Annex TEST ID 6  
Prepared by RE  
Rev.0, 25.01.2011  
No. 71.9.3

**Harness Test** **Test ID 7**

**Item:** Reflex 2  
**Manufacturer:** KARPO FLY s.r.o.  
**Test place & date:** Villeneuve March 20, 2013  
**Test responsible:** Alain Zoller  
**Temp. [°C] & Humidity:** 24,6°C; 29 %rel  
**Maximum certified pilot weight [kg]:** 120 kg

**Standard:** 2. DV LuftGerPV §1, Nr. 7 c  
**Test standard §:** 4.2.1.b rescue  
**Test setup:** Flying position before landing: seat board (11) in landing position, leg straps (10) closed.  
**Anchoring: Attachment points:** Both of the rescue riser attachments attached (1 and 2);  
**Dummy:** Default, hip fixed (7, 8)  
**Required load in g:** 6 g  
**Min load [N]:** 6 000 N  
**Required test load in kg:** 720 kg  
**Min. duration [s]:** 10 s

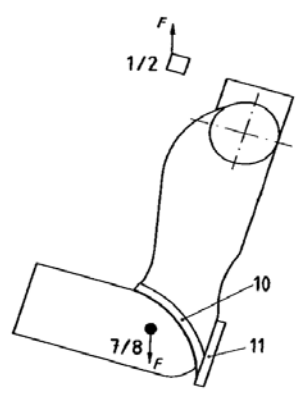

**Results**

**Duration of maintained min. load [s]:** 11.1 s  
**Any signs of structural failure after this test:** No visible failure  
**Test result:** Passed

**Graph:**

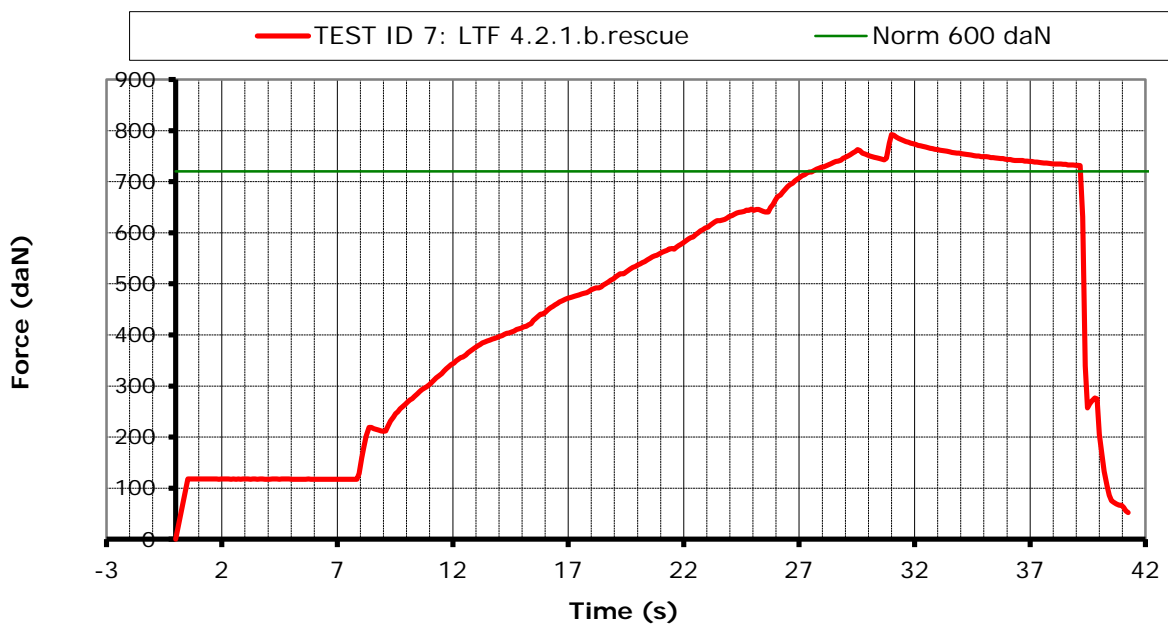

Air Turquoise SA certified by



**Air Turquoise S.A. - Certification of paraglider equipment**  
 Tested in accordance with EN 1651:1999 and 2.DV LuftGerPV§1, Nr.7c

Annex TEST ID 7  
 Prepared by RE  
 Rev.0, 25.01.2011  
 No. 71.9.3



## Harness Test

## Test ID 8

Item: Reflex 2  
 Manufacturer: KARPO FLY s.r.o.  
 Test place & date: Villeneuve March 20, 2013  
 Test responsible: Alain Zoller  
 Temp. [°C] & Humidity: 24,6°C; 29 %rel  
 Maximum certified pilot weight [kg]: 120 kg

Standard: EN 1651  
 Test standard §: 5.3.2.3  
 Test setup: Only one riser attached

Anchoring: Attachment points: One main riser attachments (3)

Dummy: Hip fixed (7, 8 -> 12)

Required load in g: 6 g  
 Min load [N]: 6 000 N  
 Required test load in kg: **720 kg**  
 Min. duration [s]: 10 s

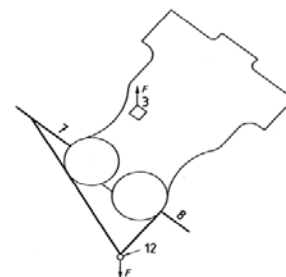

### Results

Duration of maintained min. load [s]: **11.3 s**

Any signs of structural failure after this test: **No visible failure**

Test result: **Passed**

### Graph:

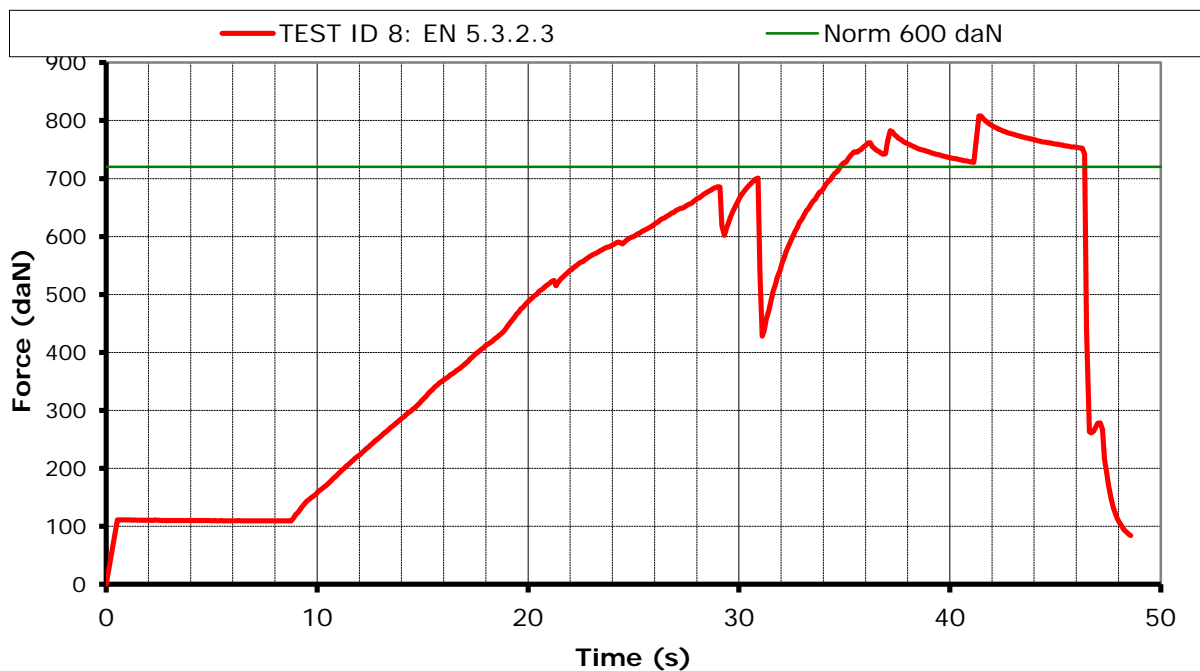

Air Turquoise SA certified by



Air Turquoise S.A. - Certification of paraglider equipment  
 Tested in accordance with EN 1651:1999 and 2.DV LuftGerPV§1, Nr.7c

Annex TEST ID 8  
 Prepared by RE  
 Rev.0, 25.01.2011  
 No. 71.9.3



## Harness Test

## Test ID 10

Item:	Reflex 2	
Manufacturer	KARPO FLY s.r.o.	
Test place & date:	Villeneuve	March 20, 2013
Test responsible:	Alain Zoller	
Temp. [°C] & Humidity:	24,6°C; 29 %rel	
Maximum certified pilot weight [kg]:	120	kg

<b>Standard</b>	EN 1651	
<b>Test standard §:</b>	5.3.2.6	
<b>Test setup:</b>	Normal flying position in NEGATIF	
<b>Anchoring: Attachment points:</b>	ONE of the main riser attachments attached downwards(3 or 4);	
<b>Dummy:</b>	Dummy anchored at the head position (9)	
<b>Required load in g:</b>	4.5	g
<b>Min load [N]:</b>	4500 N	
<b>Required test load in kg:</b>	<b>540</b>	<b>kg</b>
<b>Min. duration [s]:</b>	10 s	

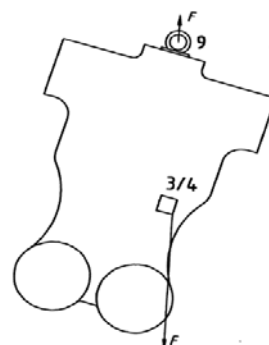

### Results

<b>Duration of maintained min. load [s]:</b>	<b>11.2 s</b>
<b>Any signs of structural failure after this test:</b>	<b>No visible failure</b>
<b>Test result:</b>	<b>Passed</b>

### Graph:

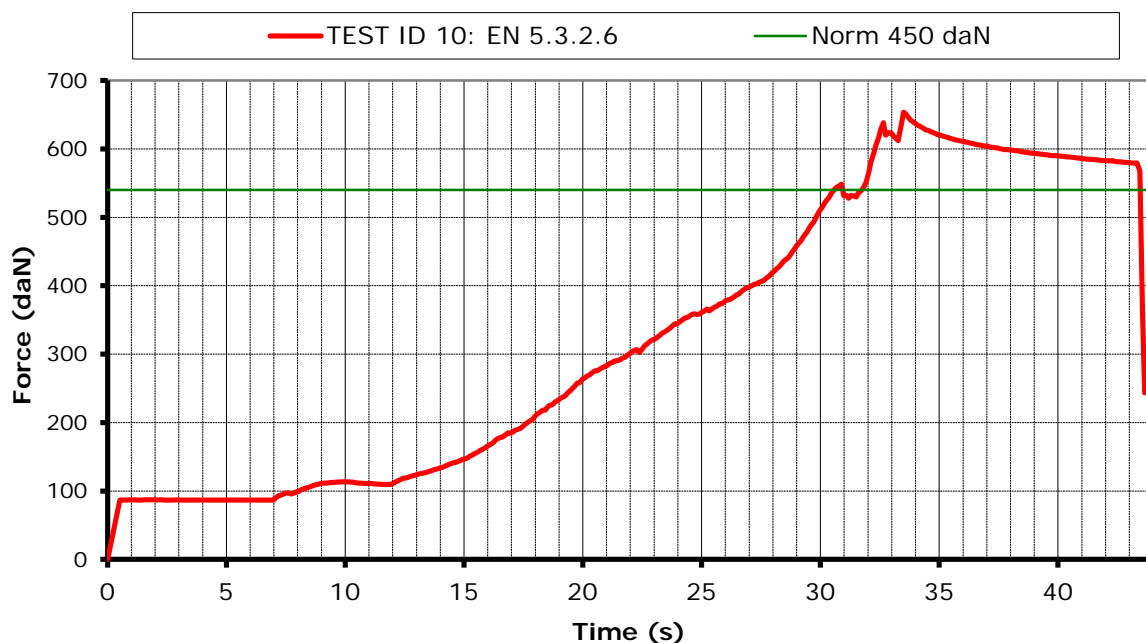

Air Turquoise SA certified by



**Air Turquoise S.A. - Certification of paraglider equipment**  
Tested in accordance with EN 1651:1999 and 2.DV LuftGerPV§1, Nr.7c

Annex TEST ID 10  
Prepared by RE  
Rev.0, 25.01.2011  
No. 71.9.3

**Harness Test**

**Test ID 11**

Item: Reflex 2  
 Manufacturer: KARPO FLY s.r.o.  
 Test place & date: Villeneuve March 20, 2013  
 Test responsible: Alain Zoller  
 Temp. [°C] & Humidity: 24,6°C; 29 %rel  
 Maximum certified pilot weight [kg]: 120 kg

Standard: 2. DV LuftGerPV §1, Nr. 7 c

Test standard §: 4.2.1.c

Test setup: Pilot upside down flying position

Anchoring: Attachment points: Both of the main riser attachments attached downwards (3 and 4);  
 Dummy: Dummy anchored at the head position (9)

Required load in g: 6 g  
 Min load [N]: 6 000 N  
 Required test load in kg: **720 kg**  
 Min. duration [s]: 10 s

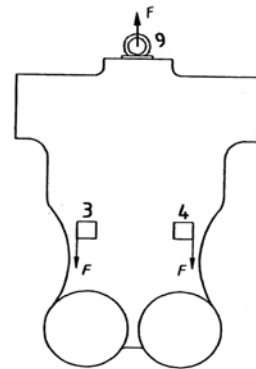

**Results**

Duration of maintained min. load [s]: **11.5 s**

Any signs of structural failure after this test: **No visible failure**

Test result: **Passed**

**Graph:**

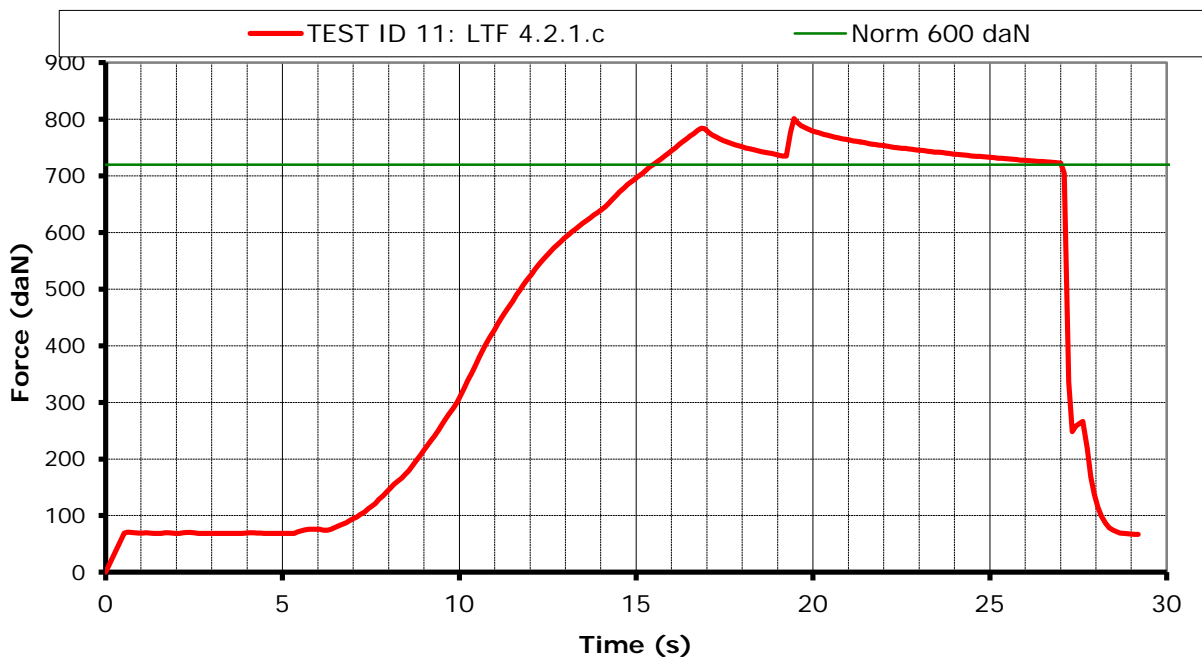

Air Turquoise SA certified by



**Air Turquoise S.A. - Certification of paraglider equipment**  
 Tested in accordance with EN 1651:1999 and 2.DV LuftGerPV§1, Nr.7c

Annex TEST ID 11  
 Prepared by RE  
 Rev.0, 25.01.2011  
 No. 71.9.3





**Harness Test**

**Test ID 12**

**Item:** Reflex 2  
**Manufacturer:** KARPO FLY s.r.o.  
**Test place & date:** Villeneuve March 20, 2013  
**Test responsible:** Alain Zoller  
**Temp. [°C] & Humidity:** 24,6°C; 29 %rel  
**Maximum certified pilot weight [kg]:** 120 kg

**Standard** 2. DV LuftGerPV §1, Nr. 7 c

**Test standard §:** 4.2.1.c rescue

**Test setup:** Pilot upside down flying position

**Anchoring: Attachment points:** Both of the rescue riser attachments attached downwards (1 and 2);

**Dummy:** Dummy anchored at the head position (9)

**Required load in g:** 6 g

**Min load [N]:** 6 000 N

**Required test load in kg:** **720 kg**

**Min. duration [s]:** 10 s

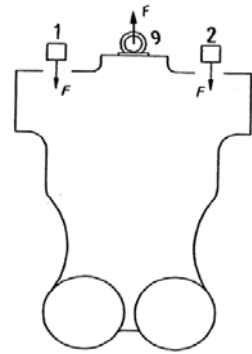

**Results**

**Duration of maintained min. load [s]:** **11.8 s**

**Any signs of structural failure after this test:** **No visible failure**

**Test result:** **Passed**

**Graph:**

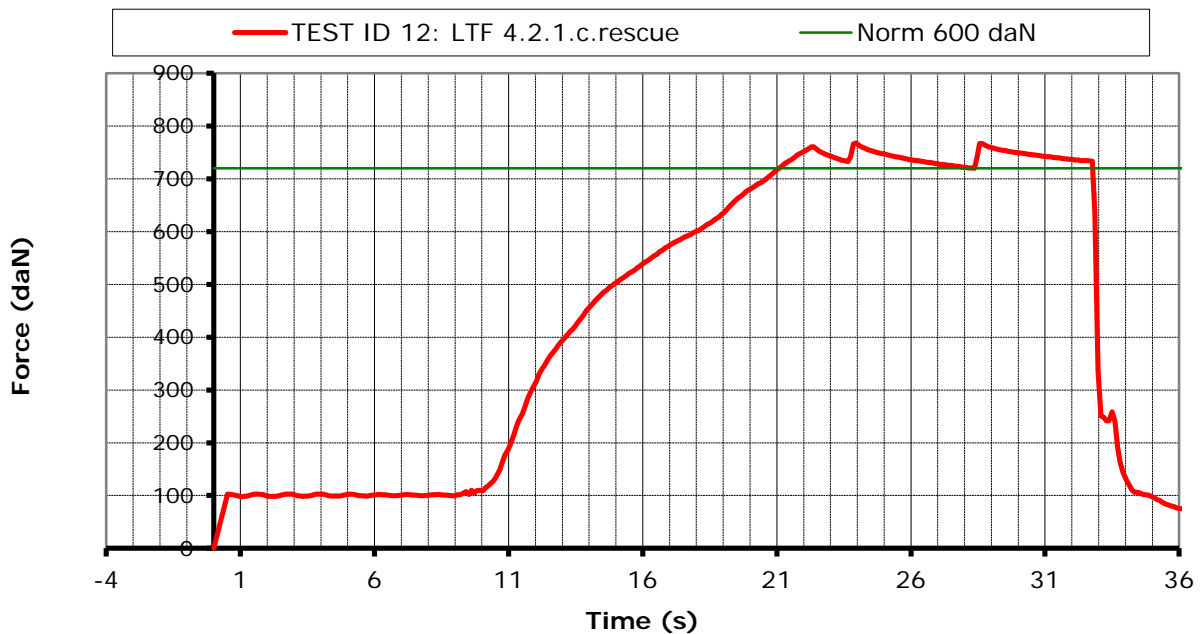

Air Turquoise SA certified by



**Air Turquoise S.A. - Certification of paraglider equipment**  
 Tested in accordance with EN 1651:1999 and 2.DV LuftGerPV§1, Nr.7c

Annex TEST ID 12  
 Prepared by RE  
 Rev.0, 25.01.2011  
 No. 71.9.3



Protector shock test		Test ID Protect
<b>Item:</b>	Reflex 2	
<b>Manufacturer</b>	KARPO FLY s.r.o.	
<b>Test place &amp; date:</b>	Villeneuve March 20, 2013	
<b>Test responsible:</b>	Alain Zoller	
<b>Temp. [°C] &amp; Humidity:</b>	24,6°C; 29 %rel	
<b>Maximum certified pilot weight [kg]:</b>	120 kg	
<b>Standard</b>	2. DV LuftGerPV §1, Nr. 7 c	
<b>Test standard §:</b>	5.1.1	
<b>Test setup:</b>	<p>Harness attached to protector test dummy, in a similar way like a real pilot in flight.</p> <p>Impact will be simulated by dropping the dummy from a certain height (with and without reserve).</p> <p>To simulate the "in-flight" conditions, the airbag is inflated with pressurized air equalling an airspeed of 7m/s. Inflation has to be stopped at least 5 sec before impact.</p> <p>Impact will be measured by an accelerometer mounted on the dummy. (Impact measured in g's)</p>	
<b>Requirements:</b>	<b>Minimum height:</b>	1.65 m (between lowest point test dummy and impact surface)
	<b>Impact requirements:</b>	+50g as absolute maximum; +38g during less than 7 msec; +20g during less than 25 msec.
	<b>Repetitions:</b>	The test will be performed 2 times, minimum 1 hour and maximum 2 hours after the first impact (with airbag protectors this pause is not necessary). The 2 Max-values should not differ more than 20%
<b>Results</b>		
<b><u>Shock test 1:</u></b>		
Impact at a height of 1.65m:	34.05 g	
Impact duration of + 38 g (if any):	0	
Impact duration of +20 g (if any):	14 ms	
<b><u>Shock test 2:</u></b>		
Impact at a height of 1.65m:	30.38 g	
Impact duration of + 38 g (if any):	0	
Impact duration of +20 g (if any):	18 ms	
<b>Test Result:</b>	<b>Passed</b>	



Graph 1:

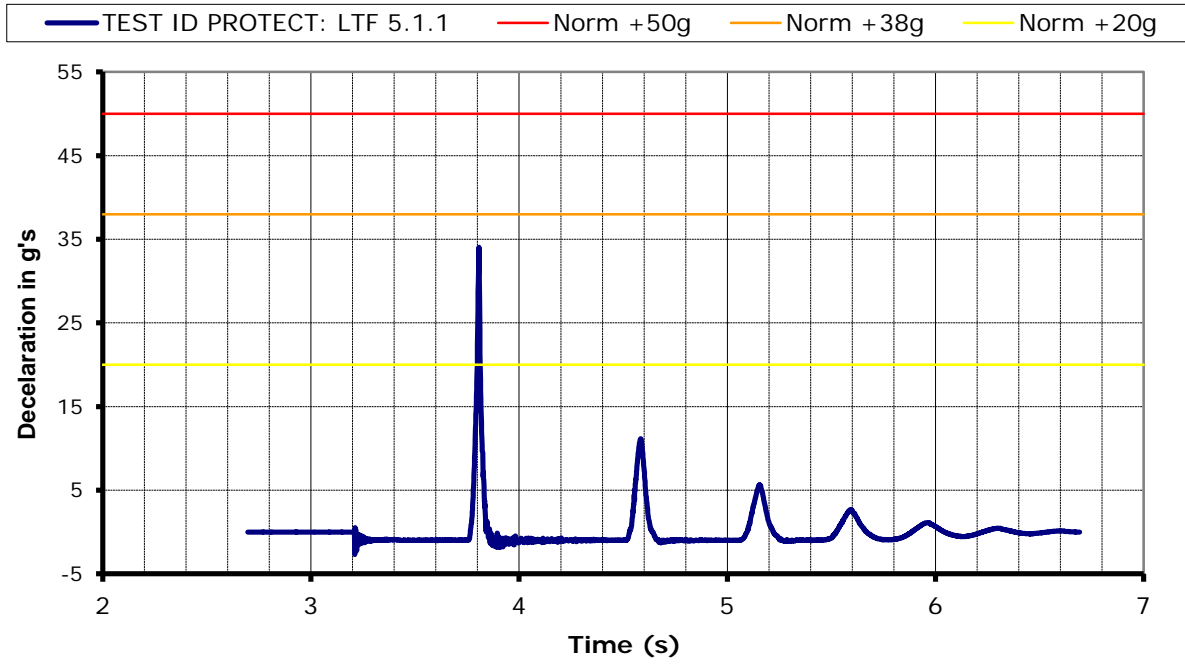

Graph 2:

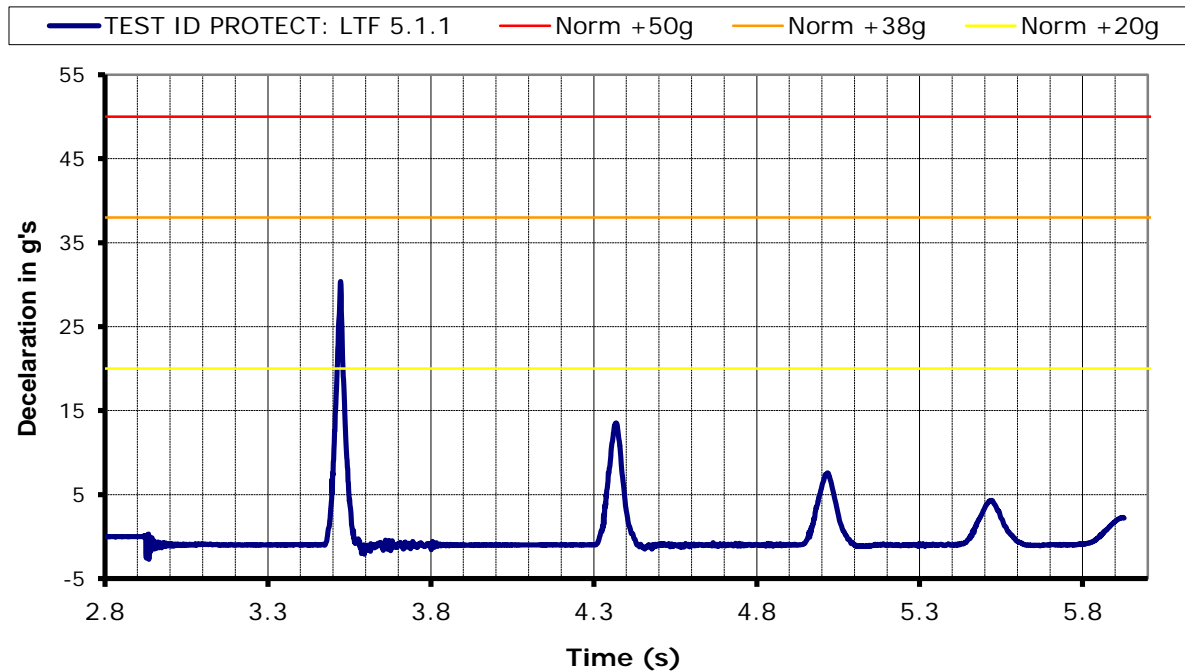

Air Turquoise SA certified by



**Air Turquoise S.A. - Certification of paraglider equipment**  
 Tested in accordance with EN 1651:1999 and 2.DV LuftGerPV§1, Nr.7c

Annex TEST ID Protect 1  
 Prepared by RE  
 Rev.0, 25.01.2011  
 No. 71.9.3



**Rescue deployment resistance test** **Test ID resc**

<b>Item:</b>	Reflex 2
<b>Manufacturer</b>	KARPO FLY s.r.o.
<b>Test place &amp; date:</b>	Villeneuve March 20, 2013
<b>Test responsible:</b>	Alain Zoller
<b>Temp. [°C] &amp; Humidity:</b>	24,6°C; 29 %rel
<b>Maximum certified pilot weight [kg]:</b>	120 kg

**Standard** 2. DV LuftGerPV §1, Nr. 7 c

**Test standard §:** 6.1.5

**Test setup:**

The deployment of the rescue system has to be ensured in all circumstances, especially with a damaged glider.

The pilot has to be able to deploy the rescue chute with a single pull out of the outer container, single handed and in an anatomical favorable direction.

In order to simulate this, the test responsible deploys the rescue seated in the harness. In a similar way as in real flight. The deployment resistance is approximately measured by the load cell, which is placed between the hand of the test responsible and the rescue hand grip.

On the other hand inadvertent deployment has to be fairly remote. Therefore a shear link has to withstand a minimum load.

<b>Requirements:</b>	<b>Max force for single hand deployment:</b>	approx. 70 N
	<b>Min force to prevent unwanted opening:</b>	approx. 20 N

**Results**

**Measured peak to peak required force for deployment [daN]:** 5.5

**Comment:** Passed

**Graph:**

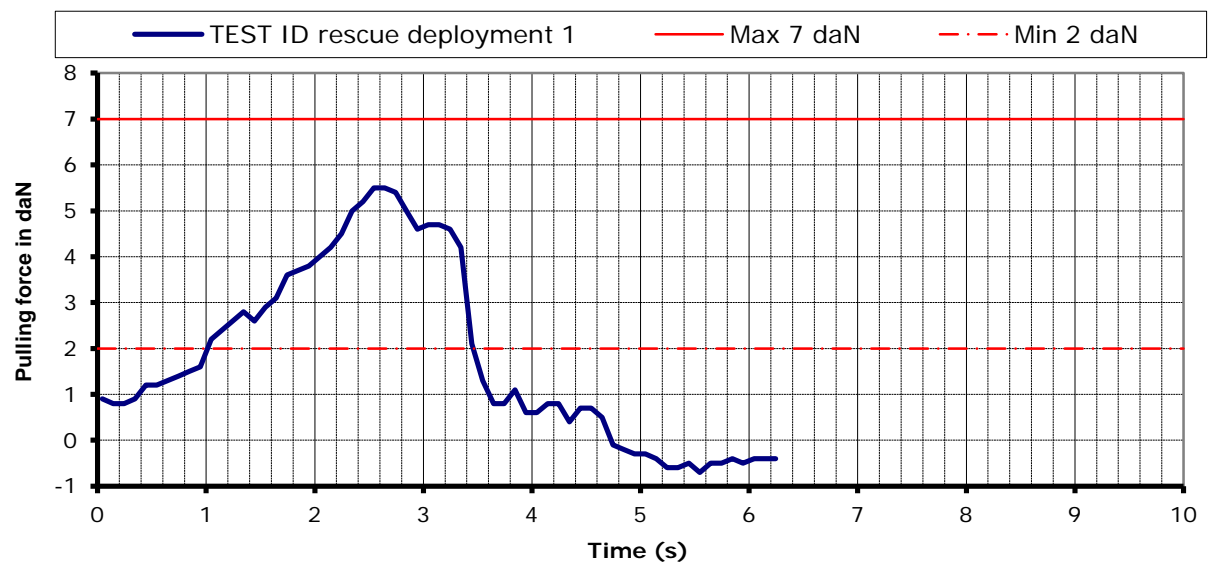

Air Turquoise SA certified by



**Air Turquoise S.A. - Certification of paraglider equipment**  
 Tested in accordance with EN 1651:1999 and 2.DV LuftGerPV§1, Nr.7c

Annex TEST ID resc depl  
 Prepared by RE  
 Rev.0, 25.01.2011  
 No. 71.9.3



## Rescue deployment strap strength test

## Test ID resc strap

Item:	Reflex 2
Manufacturer	KARPO FLY s.r.o.
Test place & date:	Villeneuve March 20, 2013
Test responsible:	Alain Zoller
Temp. [°C] & Humidity:	24,6°C; 29 %rel
Maximum certified pilot weight [kg]:	120 kg

**Standard** EN 12491 & 2. DV LuftGerPV §1, Nr. 7 c

**Test standard §:** 5.3.2 (EN 12491) & 6.1.8 (LTF)

**Test setup:**

The handgrip of the outer container has to be connected to the inner container with a removable loop in a way that it is possible to use the inner container with different types of outer containers.

The connection between handgrip and inner container has to have sufficient load capacity/structural strength in any situation that may arise during normal operation.

In order to verify this, the connection is tested on its tensile strength by a default tensile testing setup.

In addition to this the breaking resistance will also be measured.

**Requirements:** Min. tensile strenght for 10 s: 700 N (= 70daN)

### Results

Duration of maintained load [s]: **15**

Breaking resistance [daN]: **237.1**

Comment: **Passed**

### Graph:

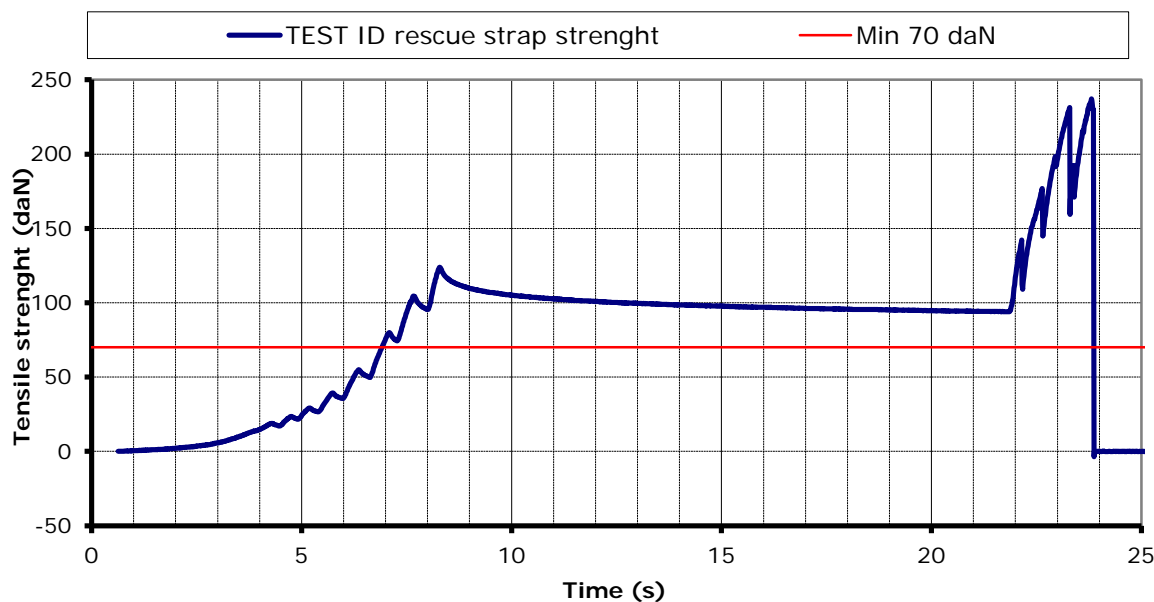

Air Turquoise SA certified by



**Air Turquoise S.A. - Certification of paraglider equipment**  
 Tested in accordance with EN 1651:1999 and 2.DV LuftGerPV§1, Nr.7c

Annex TEST ID resc strap  
 Prepared by RE  
 Rev.0, 25.01.2011  
 No. 71.9.3