

Harness Structural test Report - NfL

Inspection certificate number: **PH_405.2023**

Manufacturer data:

Manufacturer name: **Dudek Paragliders**
 Representative: **POWAIR sp. z o.o.**
 Street: **Ul. Centralna 2U**
 Post code place: **86-031 Osielsko**
 Country: **Poland**

Sample data:

Name: **Combo 2023**
 Type: **ABS**
 Size: **M**
 Serial number: **H-18898**
 Impact pad type: ⁽¹⁾ **Foam**
 Clip-in weight [kg]: **100**
 Integrated container: **Yes**
 Date of test: **11.05.2023**

Atmosphere AGL:

[C°]	21
RH [%]	49
[hPa]	1003

Summary of Structural test

Test id	- EN 1651:1999	Setup	Req. Load [g]	Req. Load [N]	Min. duration [s]	Result
02	✓ 5.3.2.1	Default flying position	6	6000	10	POSITIVE
03	✓ 5.3.2.2	Default flying position	15	15000	5	POSITIVE
04	✓ 5.3.2.3	Asymmetric, one riser	6	6000	10	POSITIVE
07	✓ 5.3.2.6	Asymmetric, negative	4.5	4500	10	POSITIVE
09	✓ 5.3.2.4	Rescue attachments	15	15000	5	POSITIVE
13	✓ 5.3.2.7	Flying position before landing	15	15000	5	POSITIVE
14	5.3.2.5	Towing	5	5000	10	n/a

Rescue deployment test

Test id	- NfL 2-565-20	Setup	Min load [N]	Max. load [N]	Measured [N]	Result
RRDT	✓ 6.1.5	Default flying position	20	70	56.62	POSITIVE

Rescue Deployment Handle strength test

Test id	- EN 12491	Setup	Req. Load [N]	Min. duration [s]	Breaking strength [N]	Result
RRST	✓ 5.3.2	Two end points of handle	700	10	1047.99	POSITIVE

Rescue deployment test with integrated container for rescue system

Test id	- NfL 2-565-20	Setup	Result
RDIC	4.3.2-4.3.6	Release of the container at maximum volume	n/a

Manufacturer	Instrument	Type no	S/N	Validity
HBM	Load Sensor GE01	1-S9M/50KN-1	31314643	04.09.2023
Burster / MTS	Load sensor 10kN SL2	8431-6010-N000S000	593507	21.04.2026
JDC elec	Geos n°11 Skywatch	Geos n°11	Unit11	18.06.2025

Air Turquoise SA, has thoroughly tested the sample mentioned above and certifies its conformity with the following standards:

NfL 2-565-20, EN12491:2015 and EN1651:1999

The validation of this test report is given by the signature of the test manager on the Inspection Certificate no 94.20a

⁽¹⁾ If Impact pad available, see test report no. 94.22 and inspection certificate no. 94.20a

Calculated values in tests reports include the value minus the uncertainty (on safe side) / The uncertainty stated is the expanded uncertainty obtained by multiplying the standard uncertainty by the coverage factor k = 2. The value of the measurand lies within the assigned range of values with a probability of 95%.

This declaration must not be reproduced in part without the written permission of AIR TURQUOISE SA

Inspection certificate number: **PH_405.2023**

model: **Combo 2023**

Harness Structural test

Test ID 02

Standard	EN 1651:1999
Reference	5.3.2.1
Test setup	Default flying position
Attachment points	Both main riser attachment (3,4)
Anchor points	Dummy (B1, B2)
Required load [g]	6
Required load [N]	6000
Minimum test duration [s]	10
Result	
Test duration [s]	11.9
Any signs of structural failure	No
Test results	POSITIVE

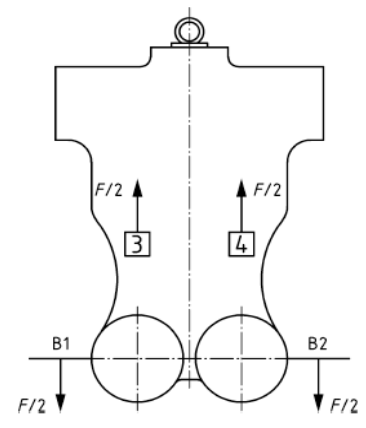
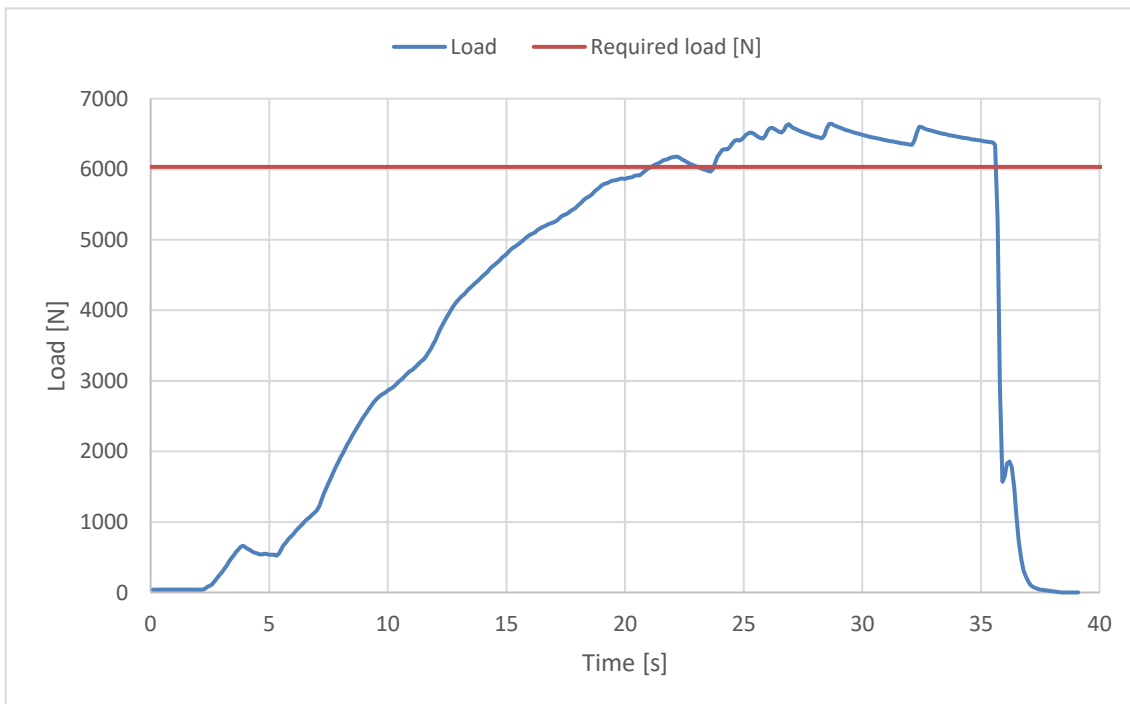
The validation of this test report is given by the signature of the test manager on the Inspection Certificate no 94.20a

Inspection certificate number: **PH_405.2023**

model: **Combo 2023**

Harness Structural test

Test ID 03

Standard **EN 1651:1999**
 Reference **5.3.2.2**
 Test setup **Default flying position**
 Attachment points **Both main riser attachment (3,4)**
 Anchor points **Dummy (B1, B2)**

Required load [g] **15**
 Required load [N] **15000**
 Minimum test duration [s] **5**

Result

Test duration [s] **8.6**
 Any signs of structural failure **No**
 Test results **POSITIVE**

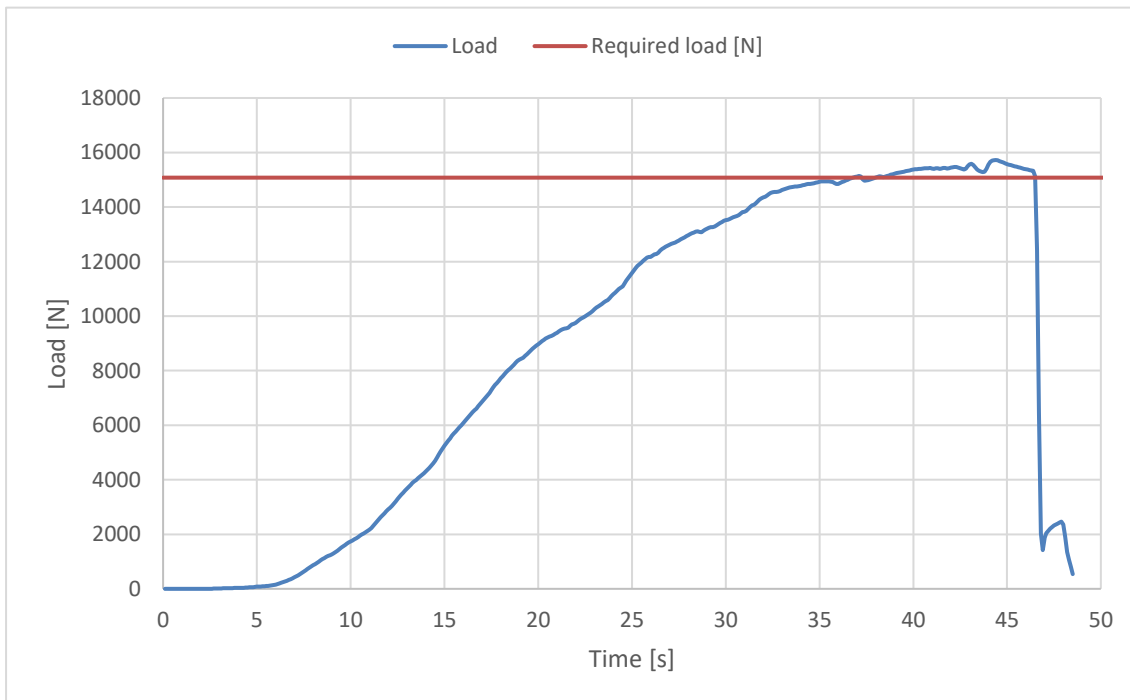
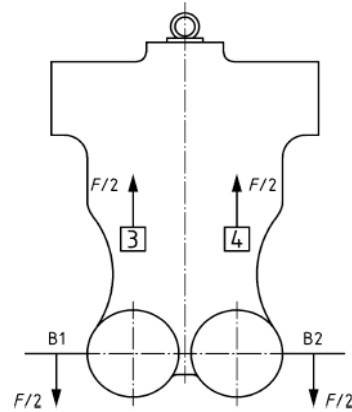

The validation of this test report is given by the signature of the test manager on the Inspection Certificate no 94.20a

Inspection certificate number: **PH_405.2023**

model: **Combo 2023**

Harness Structural test

Test ID 04

Standard **EN 1651:1999**
 Reference **5.3.2.3**
 Test setup **Asymmetric, one riser**
 Attachment points **One main riser attachment (3)**
 Anchor points **Dummy (B1,B2)**

Required load [g] **6**
 Required load [N] **6000**
 Minimum test duration [s] **10**

Result

Test duration [s] **12.6**
 Any signs of structural failure **No**
 Test results **POSITIVE**

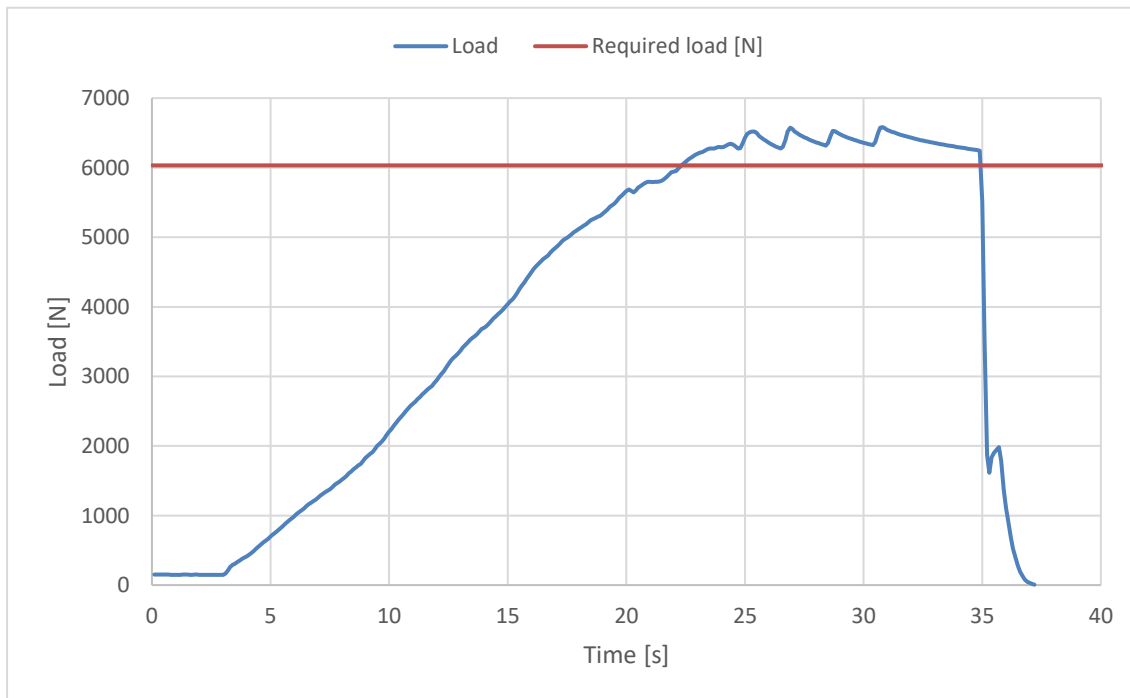
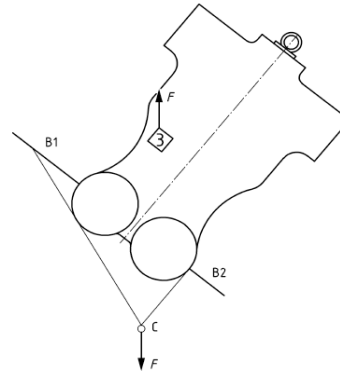

The validation of this test report is given by the signature of the test manager on the Inspection Certificate no 94.20a

Inspection certificate number: **PH_405.2023**

model: **Combo 2023**

Harness Structural test

Test ID 07

Standard	EN 1651:1999
Reference	5.3.2.6
Test setup	Asymmetric, negative
Attachment points	One main riser attachment (3 or 4) downwards
Anchor points	Dummy (9)
Required load [g]	4.5
Required load [N]	4500
Minimum test duration [s]	10
Result	
Test duration [s]	16.6
Any signs of structural failure	No
Test results	POSITIVE

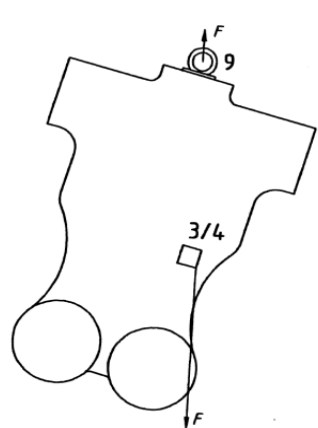
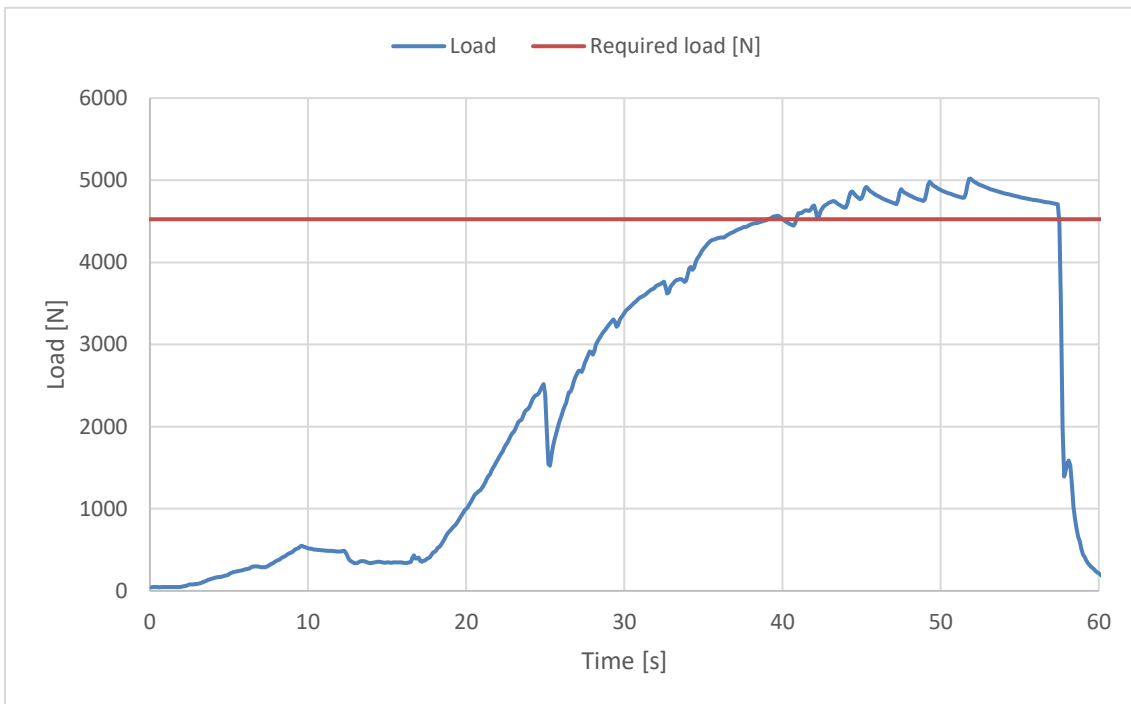
The validation of this test report is given by the signature of the test manager on the Inspection Certificate no 94.20a

Inspection certificate number: **PH_405.2023**

model: **Combo 2023**

Harness Structural test

Test ID 09

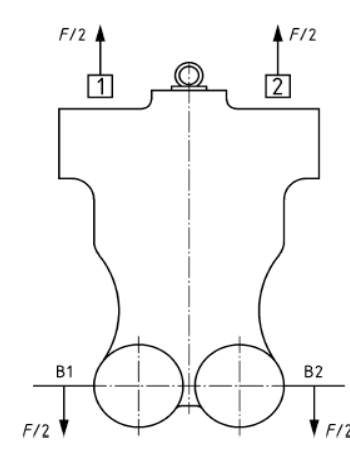
Standard	EN 1651:1999	
Reference	5.3.2.4	
Test setup	Rescue attachments	
Attachment points	Rescue riser attachment (1,2)	
Anchor points	Dummy (B1,B2)	
Required load [g]	15	
Required load [N]	15000	
Minimum test duration [s]	5	
Result		
Test duration [s]	8.3	
Any signs of structural failure	No	
Test results	POSITIVE	

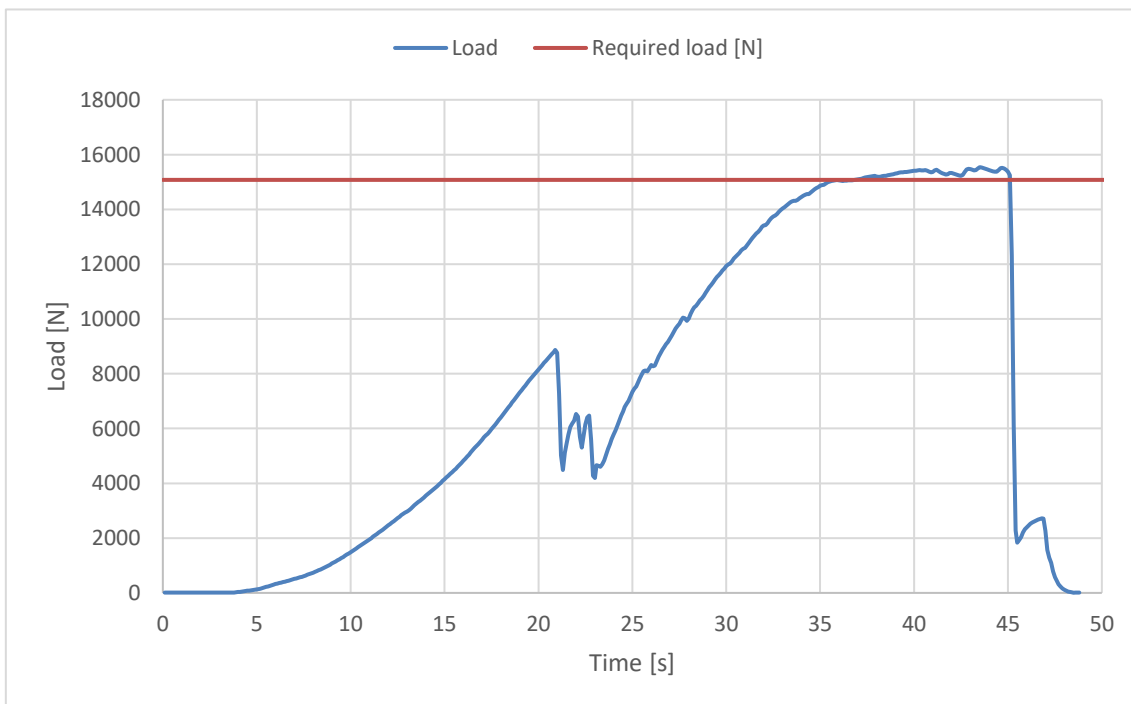

The validation of this test report is given by the signature of the test manager on the Inspection Certificate no 94.20a

Inspection certificate number: **PH_405.2023**

model: **Combo 2023**

Harness Structural test

Test ID 13

Standard **EN 1651:1999**
 Reference **5.3.2.7**
 Test setup **Flying position before landing**
 Attachment points **Both main riser attachment (3,4)**
 Anchor points **Dummy (7,8)**

Required load [g] **15**
 Required load [N] **15000**
 Minimum test duration [s] **5**

Result

Test duration [s] **7.8**
 Any signs of structural failure **No**
 Test results **POSITIVE**

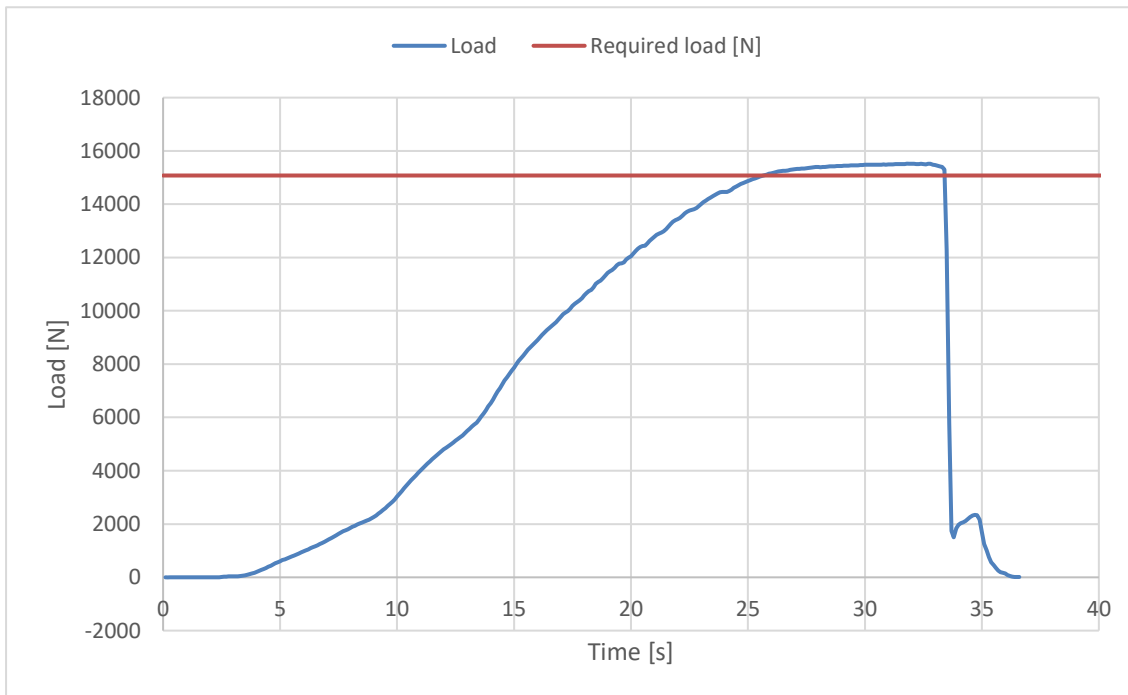
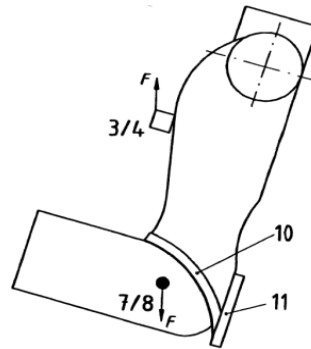

The validation of this test report is given by the signature of the test manager on the Inspection Certificate no 94.20a

Inspection certificate number: **PH_405.2023**

model: **Combo 2023**

Rescue Deployment Test

Test ID RRDT

Standard	NfL 2-565-20
Reference	6.1.5
Test setup	Default flying position
Attachment points	Sensor connect to handle, and pull in opening direction
	The test is to simulate the load required to open the emergency parachute(1st action).
Min. Required load [N]	20
Max. Required load [N]	70
Result	
Load for first action [N]	56.62
Test results	POSITIVE

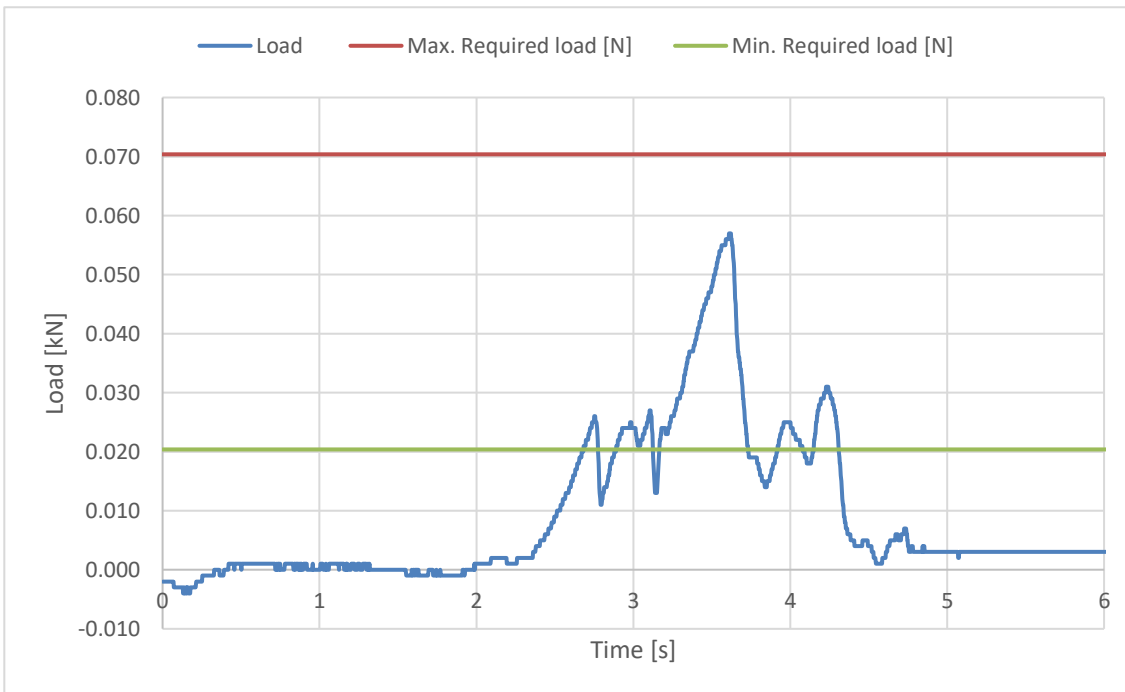

The validation of this test report is given by the signature of the test manager on the Inspection Certificate no 94.20a

Inspection certificate number: **PH_405.2023**

model: **Combo 2023**

Rescue Deployment Handle strength test

Test ID RRST

Standard	EN 12491
Reference in standard	5.3.2
Test setup	Two end points of handle
Attachment points	Sensor connect to end of handle, pull on the other side
	The handle must support min 700 N for 10 s, after measure breaking strength
Min. Required load [N]	700
Minimum test duration [s]	10
Result	
Test duration [s]:	23.4
Breaking strength [N]	1047.99
Test results	POSITIVE

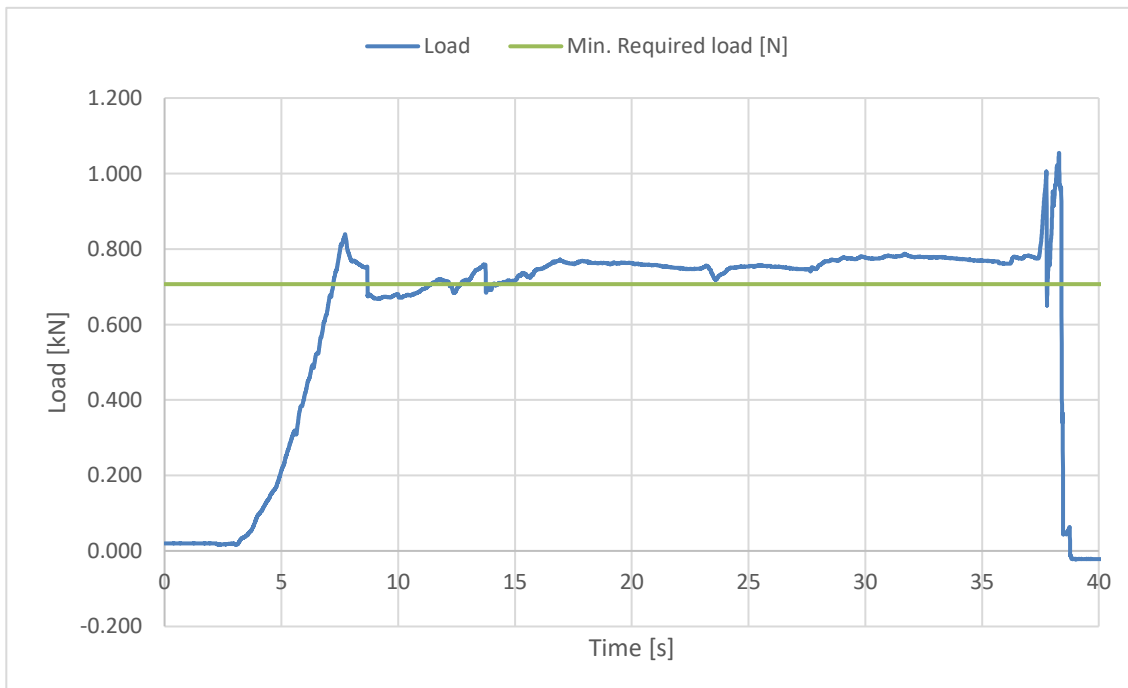

The validation of this test report is given by the signature of the test manager on the Inspection Certificate no 94.20a