

## Harness Structural test Report - NfL

Inspection certificate number: **PH\_408.2023**

### Manufacturer data:

Manufacturer name: **AirDesign GmbH**  
 Representative: **Stephan Stiegler**  
 Street: **Rhomerstrasse 9, 4. Stock**  
 Post code place: **A-6067 Absam**  
 Country: **Austria**

### Sample data:

Name: **Le Slip 2**  
 Type: **ABS**  
 Size: **M**  
 Serial number: **AN23045047-0**  
 Impact pad type: <sup>(1)</sup> **Airbag**  
 Clip-in weight [kg]: **120**  
 Integrated container: **No**  
 Date of test: **25.05.2023**

### Atmosphere AGL:

[C°]	<b>21</b>
RH [%]	<b>50</b>
[hPa]	<b>1006</b>

### Summary of Structural test

Test id	- EN 1651:1999	Setup	Req. Load [g]	Req. Load [N]	Min. duration [s]	Result
02	✓ 5.3.2.1	Default flying position	6	7200	10	POSITIVE
03	✓ 5.3.2.2	Default flying position	15	18000	5	POSITIVE
04	✓ 5.3.2.3	Asymmetric, one riser	6	7200	10	POSITIVE
07	✓ 5.3.2.6	Asymmetric, negative	4.5	5400	10	POSITIVE
09	5.3.2.4	Rescue attachments	15	18000	5	n/a
13	✓ 5.3.2.7	Flying position before landing	15	18000	5	POSITIVE
14	5.3.2.5	Towing	5	6000	10	n/a

### Rescue deployment test

Test id	- NfL 2-565-20	Setup	Min load [N]	Max. load [N]	Measured [N]	Result
RRDT	6.1.5	Default flying position	20	70	0.00	n/a

### Rescue Deployment Handle strength test

Test id	- EN 12491	Setup	Req. Load [N]	Min. duration [s]	Breaking strength [N]	Result
RRST	5.3.2	Two end points of handle	700	10	0.00	n/a

### Rescue deployment test with integrated container for rescue system

Test id	- NfL 2-565-20	Setup	Result
RDIC	4.3.2-4.3.6	Release of the container at maximum volume	n/a

Manufacturer	Instrument	Type no	S/N	Validity
HBM	Load Sensor GE01	1-S9M/50KN-1	31314643	04.09.2023
Burster / MTS	Load sensor 10kN SL2	8431-6010-N000S000	593507	21.04.2026
JDC elec	Geos n°11 Skywatch	Geos n°11	Unit11	18.06.2025

Air Turquoise SA, has thoroughly tested the sample mentioned above and certifies its conformity with the following standards:

**NfL 2-565-20, EN12491:2015 and EN1651:1999**

The validation of this test report is given by the signature of the test manager on the Inspection Certificate no 94.20a

<sup>(1)</sup> If Impact pad available, see test report no. 94.22 and inspection certificate no. 94.20a

Calculated values in tests reports include the value minus the uncertainty (on safe side) / The uncertainty stated is the expanded uncertainty obtained by multiplying the standard uncertainty by the coverage factor k = 2. The value of the measurand lies within the assigned range of values with a probability of 95%.

This declaration must not be reproduced in part without the written permission of AIR TURQUOISE SA

Inspection certificate number: **PH\_408.2023**

model: **Le Slip 2**

**Harness Structural test**

**Test ID 02**

Standard	<b>EN 1651:1999</b>
Reference	<b>5.3.2.1</b>
Test setup	<b>Default flying position</b>
Attachment points	<b>Both main riser attachment (3,4)</b>
Anchor points	<b>Dummy (B1, B2)</b>
Required load [g]	<b>6</b>
Required load [N]	<b>7200</b>
Minimum test duration [s]	<b>10</b>
<b>Result</b>	
Test duration [s]	<b>17.4</b>
Any signs of structural failure	<b>No</b>
Test results	<b>POSITIVE</b>

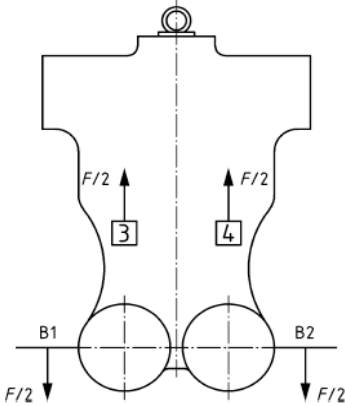
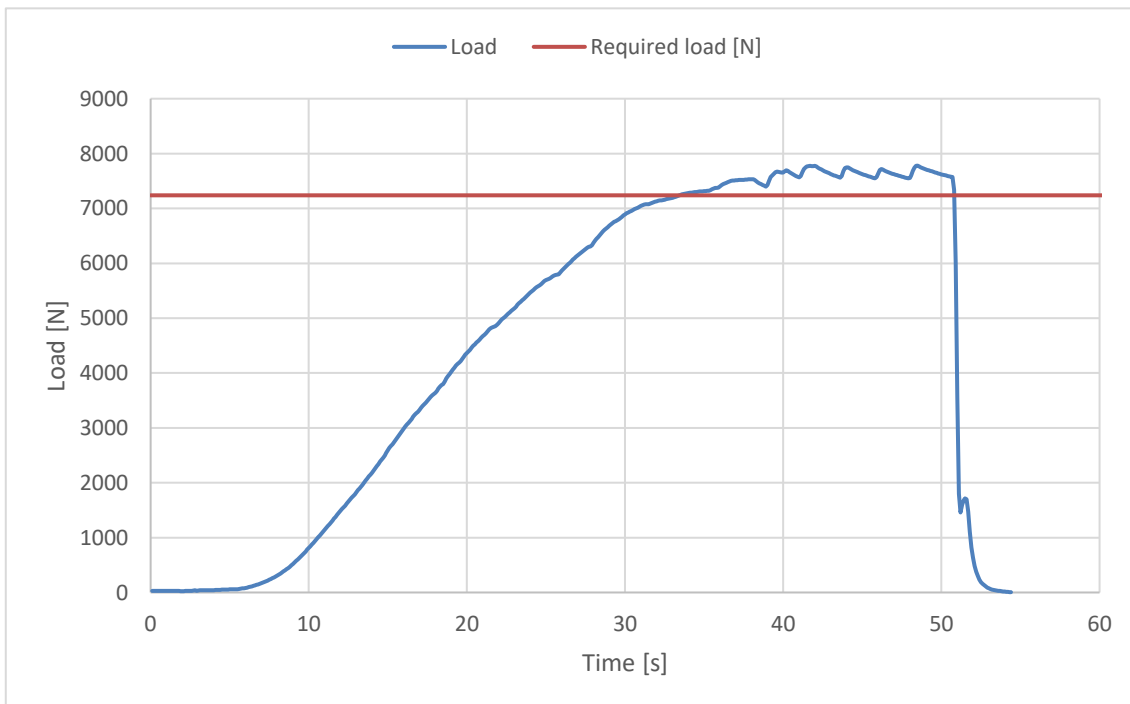
The validation of this test report is given by the signature of the test manager on the Inspection Certificate no 94.20a

Inspection certificate number: **PH\_408.2023**

model: **Le Slip 2**

**Harness Structural test**

**Test ID 03**

Standard	<b>EN 1651:1999</b>
Reference	<b>5.3.2.2</b>
Test setup	<b>Default flying position</b>
Attachment points	<b>Both main riser attachment (3,4)</b>
Anchor points	<b>Dummy (B1, B2)</b>
Required load [g]	<b>15</b>
Required load [N]	<b>18000</b>
Minimum test duration [s]	<b>5</b>
<b>Result</b>	
Test duration [s]	<b>8.4</b>
Any signs of structural failure	<b>No</b>
Test results	<b>POSITIVE</b>

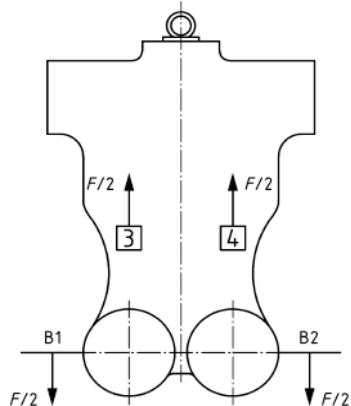
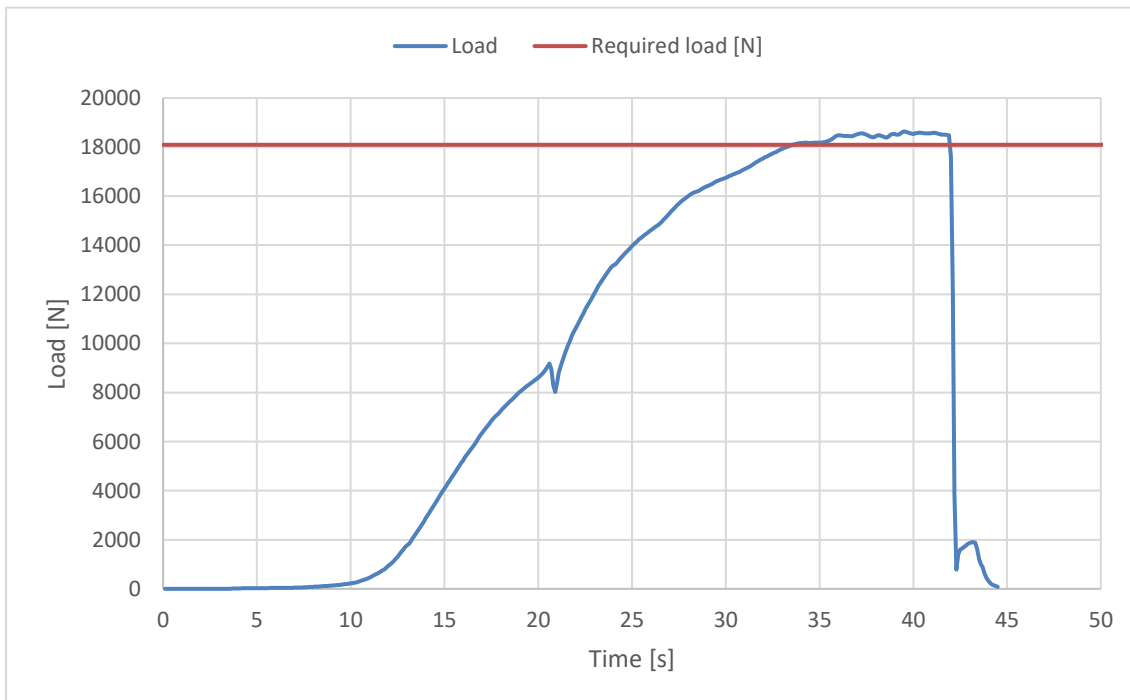
The validation of this test report is given by the signature of the test manager on the Inspection Certificate no 94.20a

Inspection certificate number: **PH\_408.2023**

model: **Le Slip 2**

**Harness Structural test**

**Test ID 04**

Standard **EN 1651:1999**  
 Reference **5.3.2.3**  
 Test setup **Asymmetric, one riser**  
 Attachment points **One main riser attachment (3)**  
 Anchor points **Dummy (B1,B2)**

Required load [g] **6**  
 Required load [N] **7200**  
 Minimum test duration [s] **10**

**Result**

Test duration [s] **12.6**  
 Any signs of structural failure **No**  
 Test results **POSITIVE**

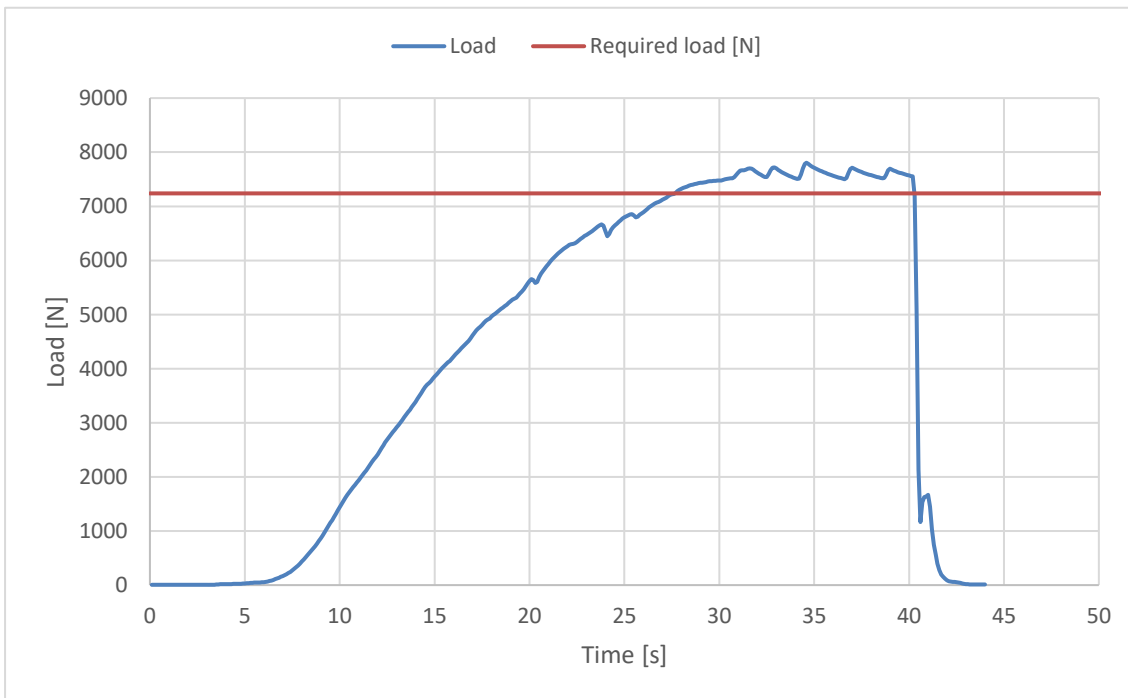
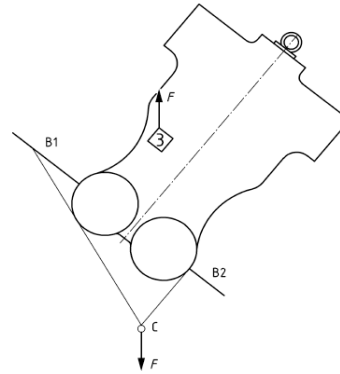

The validation of this test report is given by the signature of the test manager on the Inspection Certificate no 94.20a

Inspection certificate number: **PH\_408.2023**

model: **Le Slip 2**

**Harness Structural test**

**Test ID 07**

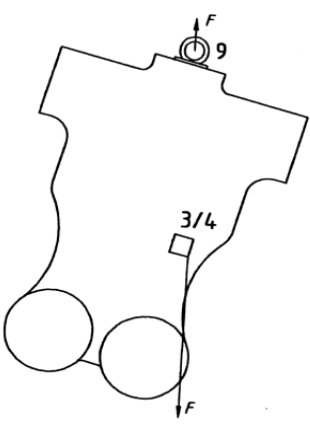
Standard	<b>EN 1651:1999</b>	
Reference	<b>5.3.2.6</b>	
Test setup	<b>Asymmetric, negative</b>	
Attachment points	<b>One main riser attachment (3 or 4) downwards</b>	
Anchor points	<b>Dummy (9)</b>	
Required load [g]	<b>4.5</b>	
Required load [N]	<b>5400</b>	
Minimum test duration [s]	<b>10</b>	
<b>Result</b>		
Test duration [s]	<b>15.7</b>	
Any signs of structural failure	<b>No</b>	
Test results	<b>POSITIVE</b>	

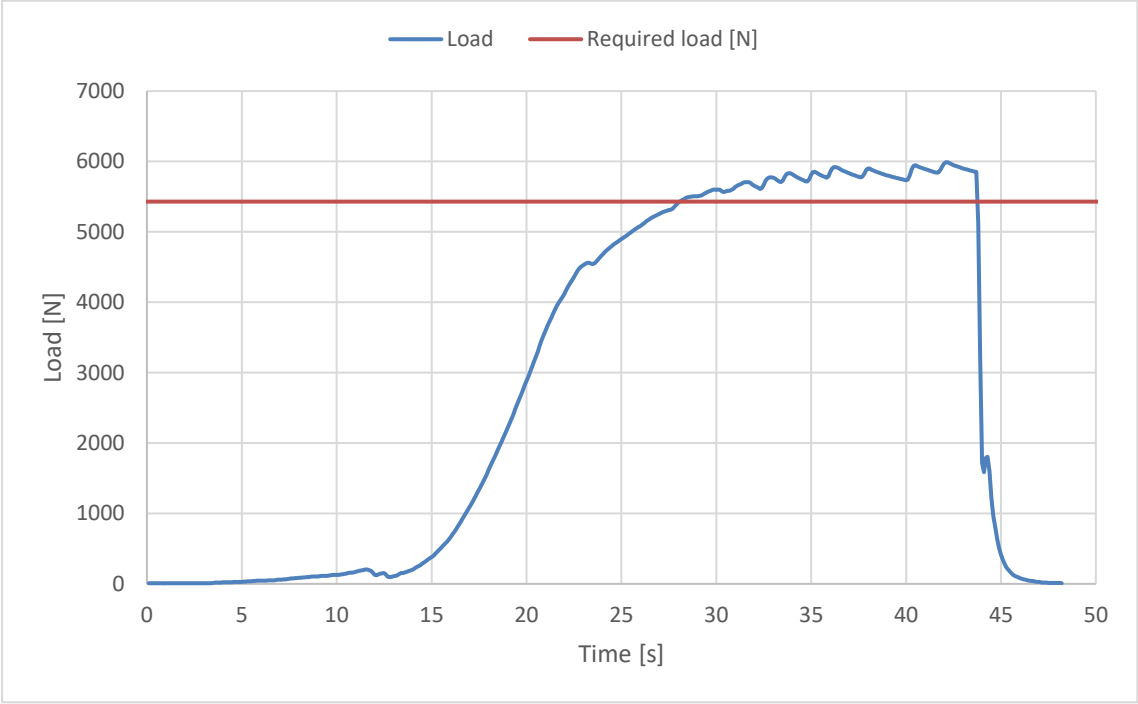

The validation of this test report is given by the signature of the test manager on the Inspection Certificate no 94.20a

Inspection certificate number: **PH\_408.2023**

model: **Le Slip 2**

**Harness Structural test**

**Test ID 13**

Standard **EN 1651:1999**  
 Reference **5.3.2.7**  
 Test setup **Flying position before landing**  
 Attachment points **Both main riser attachment (3,4)**  
 Anchor points **Dummy (7,8)**

Required load [g] **15**  
 Required load [N] **18000**  
 Minimum test duration [s] **5**

**Result**

Test duration [s] **10.7**  
 Any signs of structural failure **No**  
 Test results **POSITIVE**

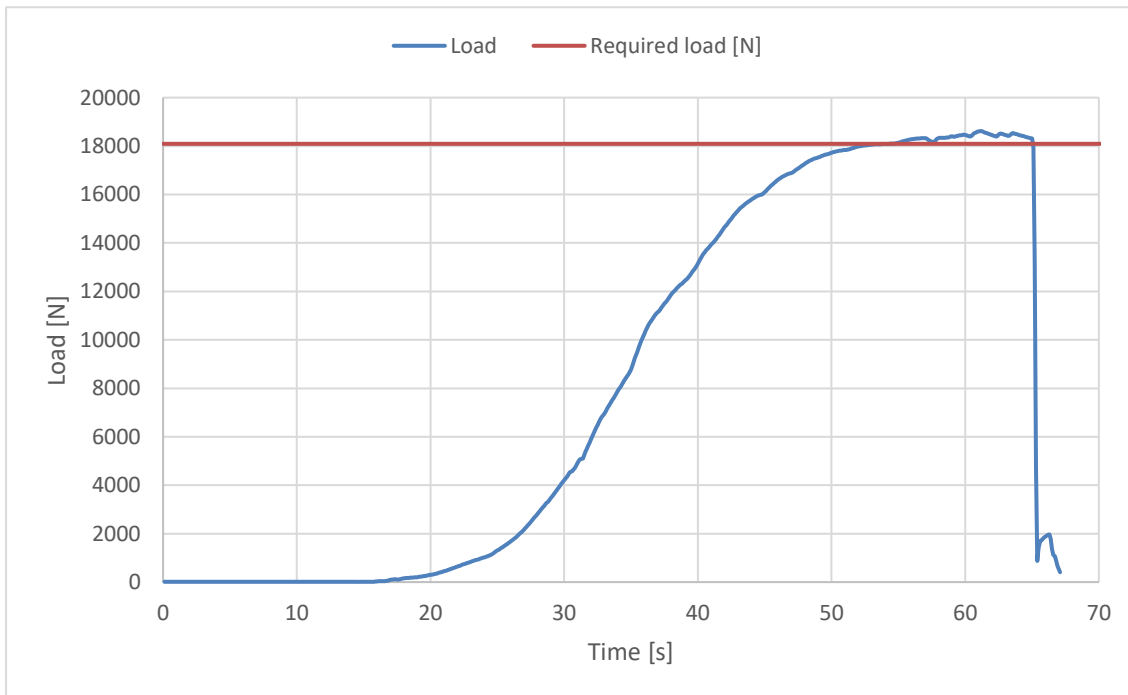
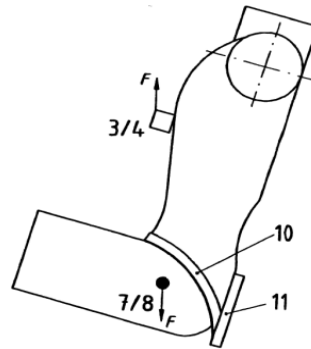

The validation of this test report is given by the signature of the test manager on the Inspection Certificate no 94.20a