

Harness Structural test Report - EN

Inspection certificate number: PH_448.2024

Manufacturer data:

Manufacturer name: **RB Paramotors**
 Representative: **Raffaele Benetti**
 Street: **Via di Picciorana II Trav. 140/N**
 Post code place: **55100 Antraccoli, Lucca**
 Country: **Italy**

Sample data:

Name: **M-Light harness**
 Type: **ABS**
 Size: **M**
 Serial number: **2954-23-5849**
 Impact pad type: ⁽¹⁾ **n/a**
 Clip-in weight [kg]: **100**

 Date of test: **29.05.2024**

Atmosphere AGL:

[C°]	23
RH [%]	51
[hPa]	1004

Summary of Structural test

Test id	- EN 1651	Setup	Req. Load [g]	Req. Load [N]	Min. duration [s]	Result
01 ⁽³⁾	V 5.5.1.1	Positive symmetric load (Slippage)	4.5	4500	5	POSITIVE
03 ⁽³⁾	V 5.5.1.1b	Positive symmetric load	15	15000	5	POSITIVE
05	V 5.5.1.2	Positive asymmetric load	6	6000	5	POSITIVE
06	V 5.5.1.6	Negative symmetric load	6	6000	5	POSITIVE
08 ⁽⁵⁾	5.5.1.9	Anti falling-out system	4.5	4500	5	n/a
09 ⁽³⁾⁽⁴⁾	5.5.1.3	Positive symmetric load rescue points	15	15000	5	n/a
10 ⁽³⁾⁽⁴⁾	5.5.1.4	Negative symmetric load rescue points	15	15000	5	n/a
11	5.5.1.8	Connecting element for rescue	n/a	24000	0.3	n/a
12 ⁽³⁾	V 5.5.1.7	Upright (landing) position load	6	6000	5	POSITIVE
14	5.5.1.5	Negative symmetric load towing points	5	5000	5	n/a

Rescue deployment test

Test id	- EN 1651	Setup	Min. load [N]	Max. load [N]	Measured [N]	Result
RRDT	5.5.1.11	Default flying position	20	70	0.00	n/a

Rescue Deployment Handle strength test

Test id	- EN 12491	Setup	Req. Load [N]	Min. duration [s]	Break. strength [N]	Result
RRST	5.3.2	Two end points of handle	700	10	0.00	n/a

Manufacturer	Instrument	Type no	S/N	Validity
HBM	Load Sensor GE01	1-S9M/50KN-1	31314643	23.08.2028
Burster / MTS	Load sensor 10kN SL2	8431-6010-N000S000	593507	23.08.2028
JDC elec	Geos n°11 Skywatch	Geos n°11	Unit11	18.06.2025

Air Turquoise SA, has thoroughly tested the sample mentioned above and certifies its conformity with the following standards:

EN1651:2018+A1:2020⁽⁶⁾ and EN12491:2015+A1:2021⁽⁶⁾

The validation of this test report is given by the signature of the test manager on the Inspection Certificate no 94.20b

⁽¹⁾ If Impact pad available, see test report no. 94.22 and inspection certificate no. 94.20b. ⁽³⁾ Slipping test of any adjustable components: No slippage of any adjustable element more than 10 mm at 4500N for 5 s. The marks should be added with a pre-load of 1000N. ⁽⁴⁾ For harness with integrated Y bridle, test in the end loop ⁽⁵⁾ Attach to anti-falling out system without connecting the crotch straps (breast straps)

⁽⁶⁾ These standards are NOT covered by accreditation D-IS-19457-01

Calculated value in tests reports include the value minus the uncertainty (on safe side) / The uncertainty stated is the expanded uncertainty obtained by multiplying the standard uncertainty by the coverage factor k = 2. The value of the measurand lies within the assigned range of values with a probability of 95%

This declaration must not be reproduced in part without the written permission of AIR TURQUOISE SA

Inspection certificate number: **PH_448.2024**

model: **M-Light harness**

Harness Structural test

Test ID 01

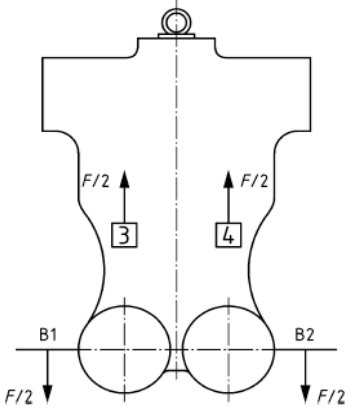
Standard	EN 1651	
Reference in standard	5.5.1.1	
Test setup	Positive symmetric load (Slippage)	
Attachment points	Both main riser attachment (3,4)	
Anchor points	Dummy (B1, B2)	
Required load [g]	4.5	
Required load [N]	4500	
Minimum test duration [s]	5	
Result		
Test duration [s]	5.8	
Any signs of structural failure	No	
Slippery test OK	Yes	
Test results	POSITIVE	

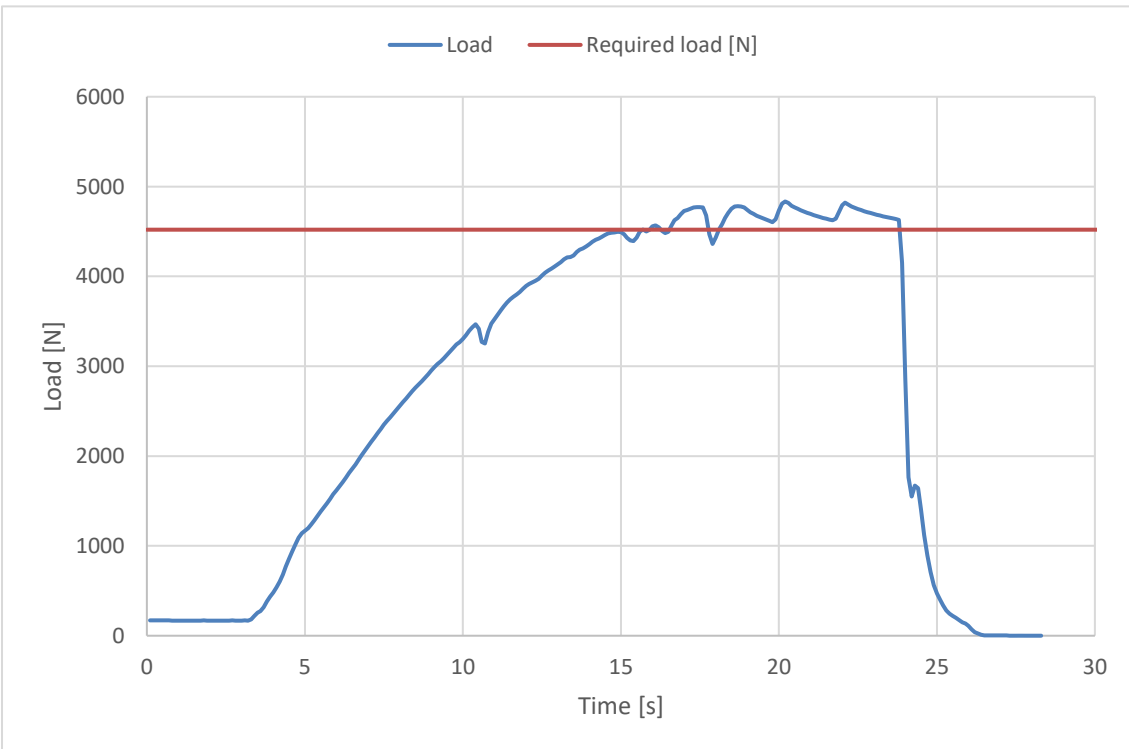

The validation of this test report is given by the signature of the test manager on the Inspection Certificate no 94.20b

Inspection certificate number: **PH_448.2024**

model: **M-Light harness**

Harness Structural test

Test ID 03

Standard **EN 1651**
 Reference in standard **5.5.1.1b**
 Test setup **Positive symmetric load**
 Attachment points **Both main riser attachment (3,4)**
 Anchor points **Dummy (B1, B2)**

Required load [g] **15**
 Required load [N] **15000**
 Minimum test duration [s] **5**

Result

Test duration [s] **5.8**
 Any signs of structural failure **No**
 Slippery test OK **Yes**
 Test results **POSITIVE**

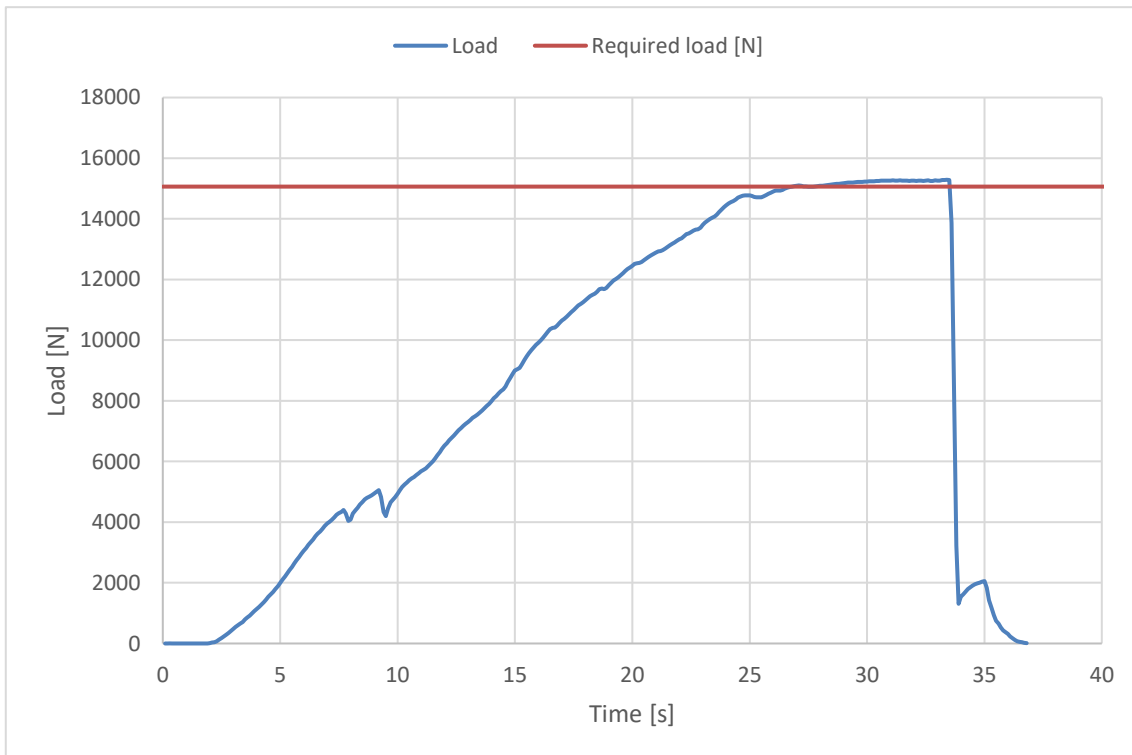
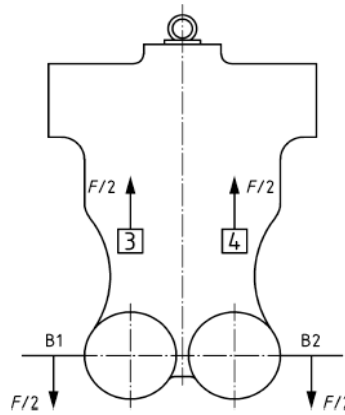

The validation of this test report is given by the signature of the test manager on the Inspection Certificate no 94.20b

Inspection certificate number: **PH_448.2024**

model: **M-Light harness**

Harness Structural test

Test ID 05

Standard	EN 1651
Reference in standard	5.5.1.2
Test setup	Positive asymmetric load
Attachment points	One riser attachment (3 or 4)
Anchor points	Dummy (C)
Required load [g]	6
Required load [N]	6000
Minimum test duration [s]	5
Result	
Test duration [s]	5.7
Any signs of structural failure	No
Test results	POSITIVE

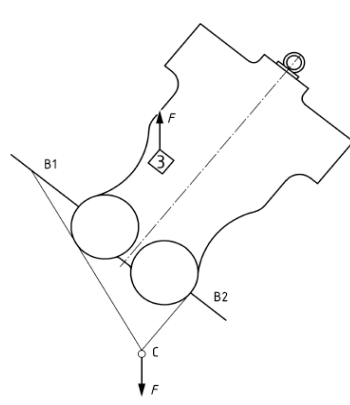
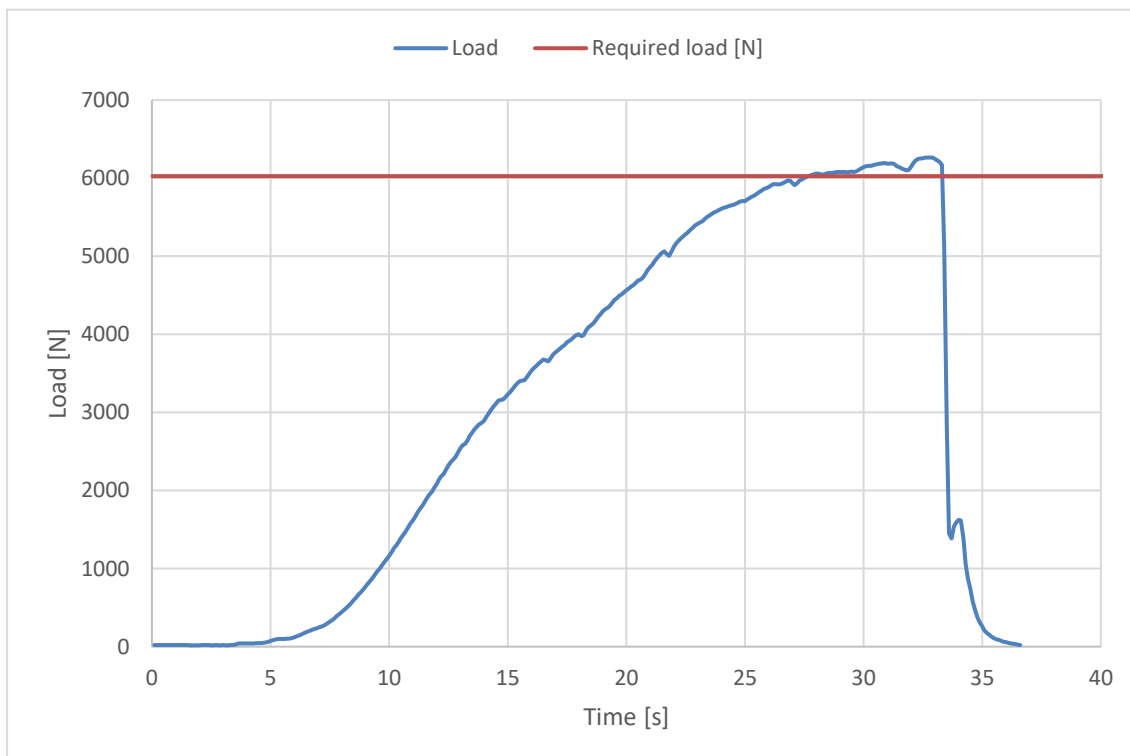
The validation of this test report is given by the signature of the test manager on the Inspection Certificate no 94.20b

Inspection certificate number: **PH_448.2024**

model: **M-Light harness**

Harness Structural test

Test ID 06

Standard	EN 1651
Reference in standard	5.5.1.6
Test setup	Negative symmetric load
Attachment points	Both main riser attachment (3,4)
Anchor points	Dummy (A)
Required load [g]	6
Required load [N]	6000
Minimum test duration [s]	5
Result	
Test duration [s]	5.7
Any signs of structural failure	No
Test results	POSITIVE

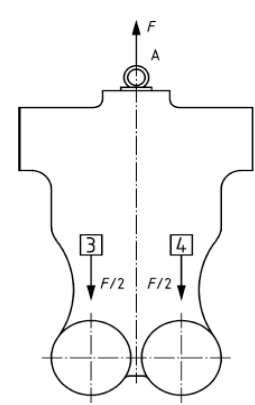
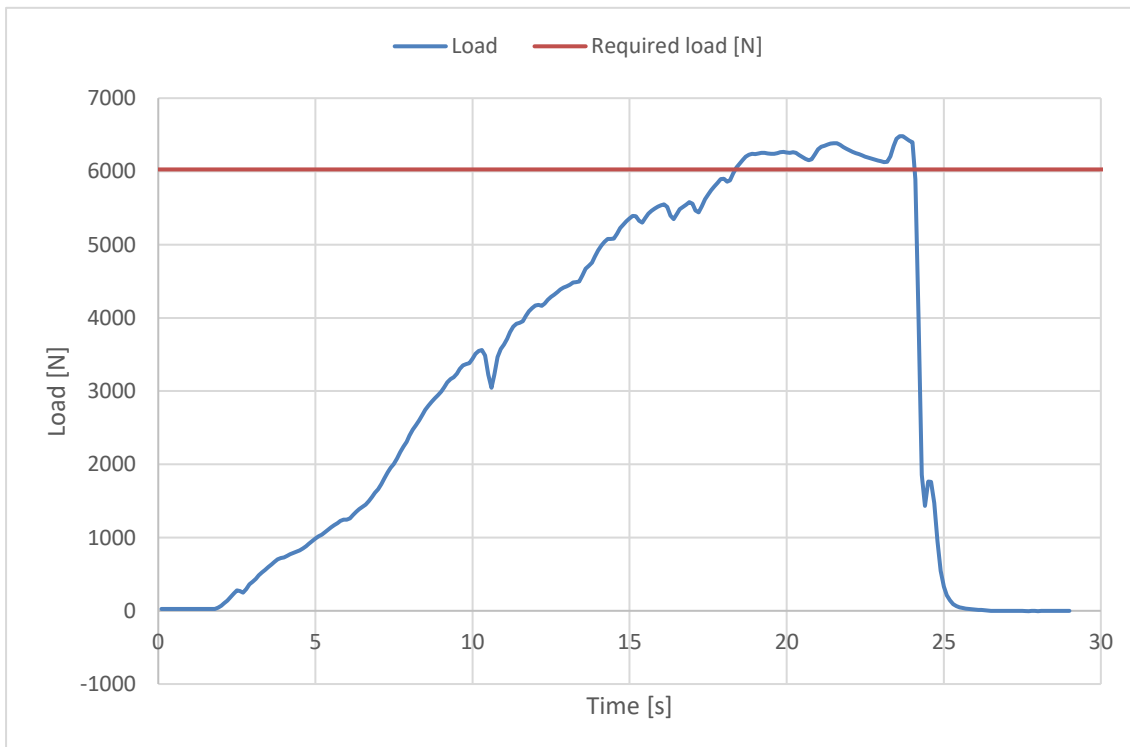
The validation of this test report is given by the signature of the test manager on the Inspection Certificate no 94.20b

Inspection certificate number: **PH_448.2024**

model: **M-Light harness**

Harness Structural test

Test ID 12

Standard	EN 1651
Reference in standard	5.5.1.7
Test setup	Upright (landing) position load
Attachment points	Both main riser attachment (3, 4)
Anchor points	Both legstrap of harness (no dummy)
Required load [g]	6
Required load [N]	6000
Minimum test duration [s]	5
Harness type	type c
Result	
Test duration [s]	5.8
Any signs of structural failure	No
Slippery test OK	Yes
Test results	POSITIVE

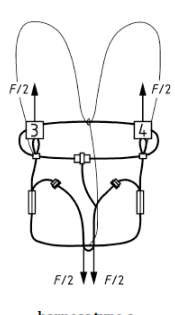
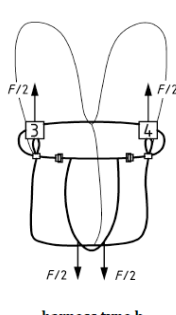
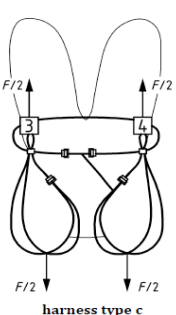

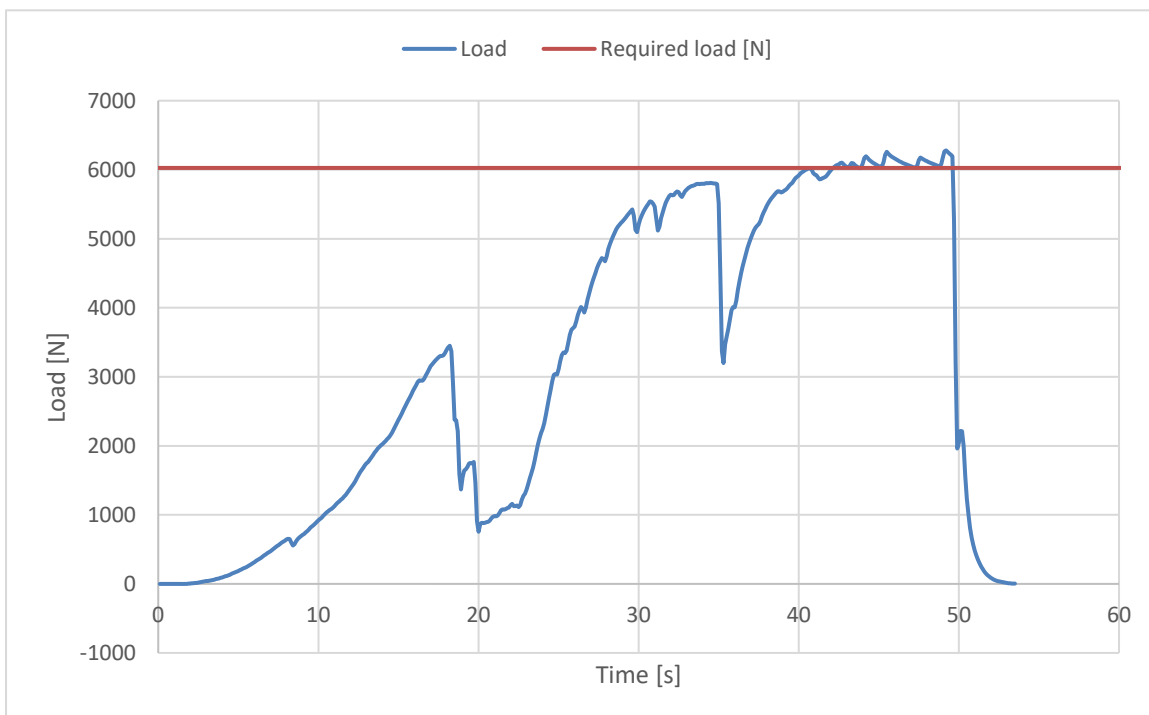
The validation of this test report is given by the signature of the test manager on the Inspection Certificate no 94.20b