

## Harness Structural test Report - NfL

Inspection certificate number: **PH\_399.2023**

### Manufacturer data:

Manufacturer name: **Nova Vertriebsgesellschaft m.b.H.**  
 Representative: **Philipp Medicus**  
 Street: **Auweg 14**  
 Post code place: **6124 Terfens**  
 Country: **Austria**

### Sample data:

Name: **ARTUS Light 2023**  
 Type: **ABS**  
 Size: **M/L**  
 Serial number: **PX001**  
 Impact pad type: <sup>(1)</sup> **Aluminium**  
 Clip-in weight [kg]: **100**  
 Integrated container: **Yes**  
 Date of test: **09.11.2020**

### Atmosphere AGL:

[C°]	<b>23</b>
RH [%]	<b>45</b>
[hPa]	<b>1024</b>

### Summary of Structural test

Test id	- EN 1651:1999	Setup	Req. Load [g]	Req. Load [N]	Min. duration [s]	Result
02	✓ 5.3.2.1	Default flying position	6	6000	10	POSITIVE
03	✓ 5.3.2.2	Default flying position	15	15000	5	POSITIVE
04	✓ 5.3.2.3	Asymmetric, one riser	6	6000	10	POSITIVE
07	✓ 5.3.2.6	Asymmetric, negative	4.5	4500	10	POSITIVE
09	5.3.2.4	Rescue attachments	15	15000	5	n/a
13	✓ 5.3.2.7	Flying position before landing	15	15000	5	POSITIVE
14	5.3.2.5	Towing	5	5000	10	n/a

### Rescue deployment test

Test id	- NfL 2-565-20	Setup	Min load [N]	Max. load [N]	Measured [N]	Result
RRDT	✓ 6.1.5	Default flying position	20	70	46.69	POSITIVE

### Rescue Deployment Handle strength test

Test id	- EN 12491	Setup	Req. Load [N]	Min. duration [s]	Breaking strength [N]	Result
RRST	✓ 5.3.2	Two end points of handle	700	10	2440.68	POSITIVE

### Rescue deployment test with integrated container for rescue system

Test id	- NfL 2-565-20	Setup	Result
RDIC	4.3.2-4.3.6	Release of the container at maximum volume	n/a

Manufacturer	Instrument	Type no	S/N	Validity
HBM	Load Sensor GE01	1-S9M/50KN-1	31314643	04.09.2023
Burster / MTS	Load sensor 10kN SL2	8431-6010-N000S000	593507	21.04.2026
JDC elec	Geos n°11 Skywatch	Geos n°11	Unit11	18.06.2025

Air Turquoise SA, has thoroughly tested the sample mentioned above and certifies its conformity with the following standards:

**NfL 2-565-20, EN12491:2015 and EN1651:1999**

The validation of this test report is given by the signature of the test manager on the Inspection Certificate no 94.20a

<sup>(1)</sup> If Impact pad available, see test report no. 94.22 and inspection certificate no. 94.20a

Calculated values in tests reports include the value minus the uncertainty (on safe side) / The uncertainty stated is the expanded uncertainty obtained by multiplying the standard uncertainty by the coverage factor k = 2. The value of the measurand lies within the assigned range of values with a probability of 95%.

This declaration must not be reproduced in part without the written permission of AIR TURQUOISE SA

Inspection certificate number: **PH\_399.2023**

model: **ARTUS Light 2023**

**Harness Structural test**

**Test ID 02**

Standard **EN 1651:1999**  
 Reference **5.3.2.1**  
 Test setup **Default flying position**  
 Attachment points **Both main riser attachment (3,4)**  
 Anchor points **Dummy (B1, B2)**

Required load [g] **6**  
 Required load [N] **6000**  
 Minimum test duration [s] **10**

**Result**

Test duration [s] **15.6**  
 Any signs of structural failure **No**  
 Test results **POSITIVE**

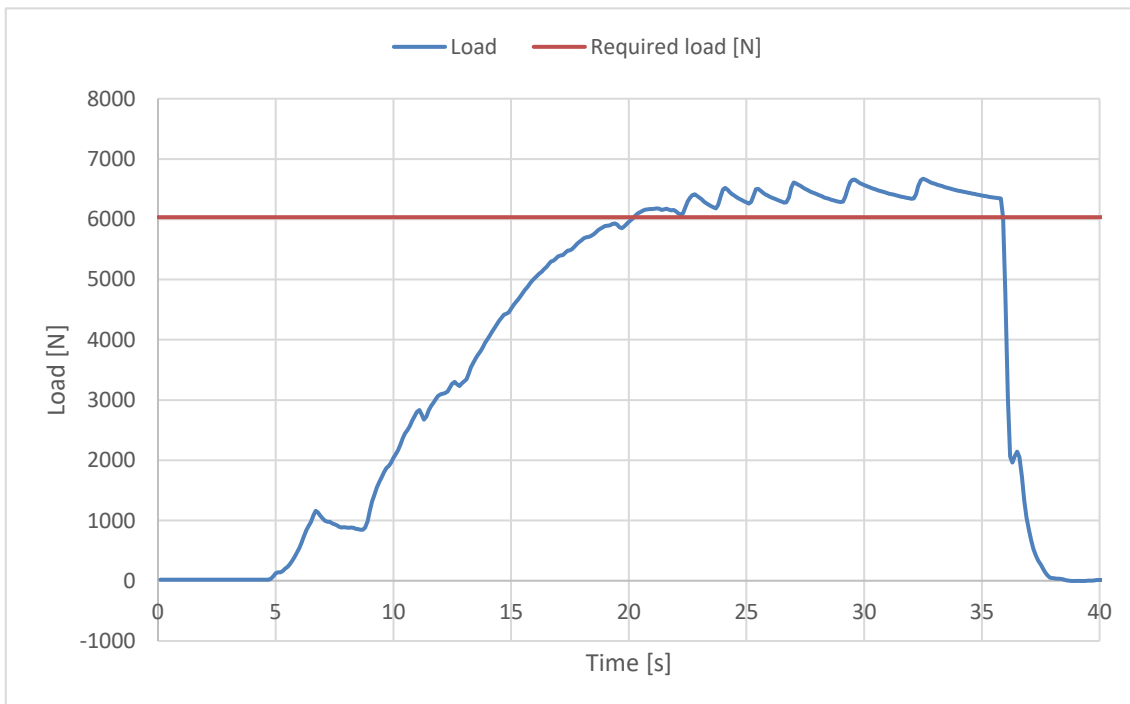
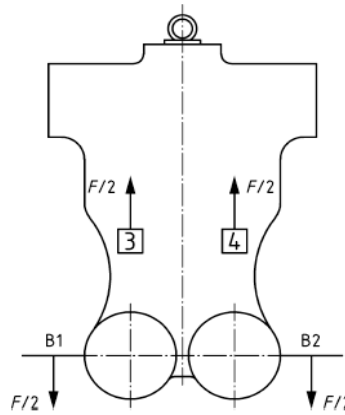

The validation of this test report is given by the signature of the test manager on the Inspection Certificate no 94.20a

Inspection certificate number: **PH\_399.2023**

model: **ARTUS Light 2023**

**Harness Structural test**

**Test ID 03**

Standard	<b>EN 1651:1999</b>
Reference	<b>5.3.2.2</b>
Test setup	<b>Default flying position</b>
Attachment points	<b>Both main riser attachment (3,4)</b>
Anchor points	<b>Dummy (B1, B2)</b>
Required load [g]	<b>15</b>
Required load [N]	<b>15000</b>
Minimum test duration [s]	<b>5</b>
<b>Result</b>	
Test duration [s]	<b>9.4</b>
Any signs of structural failure	<b>No</b>
Test results	<b>POSITIVE</b>

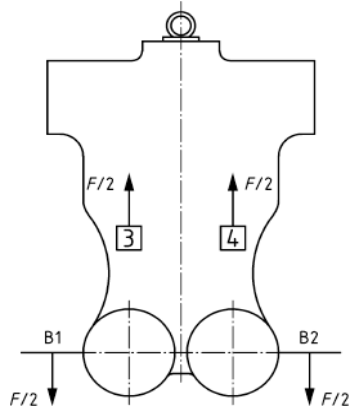
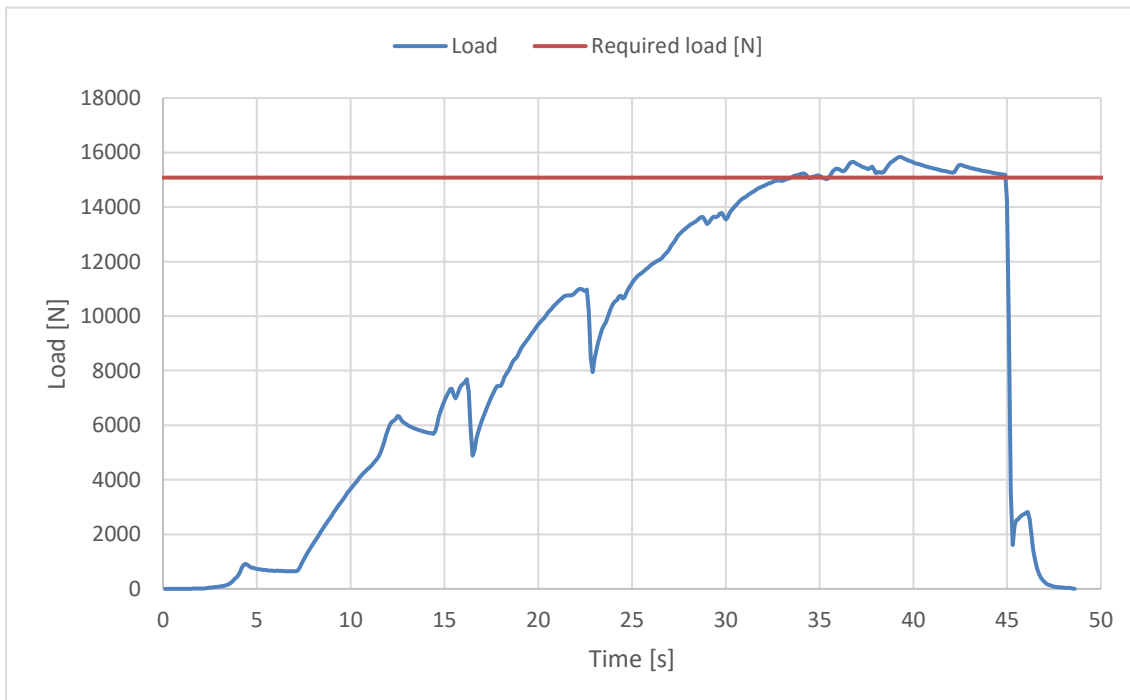
The validation of this test report is given by the signature of the test manager on the Inspection Certificate no 94.20a

Inspection certificate number: **PH\_399.2023**

model: **ARTUS Light 2023**

**Harness Structural test**

**Test ID 04**

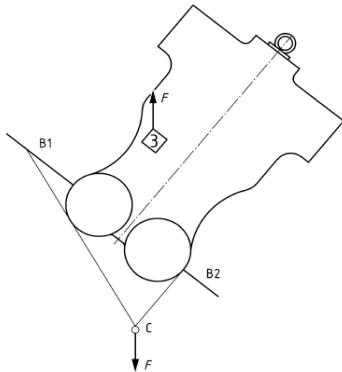
Standard	<b>EN 1651:1999</b>	
Reference	<b>5.3.2.3</b>	
Test setup	<b>Asymmetric, one riser</b>	
Attachment points	<b>One main riser attachment (3)</b>	
Anchor points	<b>Dummy (B1,B2)</b>	
Required load [g]	<b>6</b>	
Required load [N]	<b>6000</b>	
Minimum test duration [s]	<b>10</b>	
<b>Result</b>		
Test duration [s]	<b>15.1</b>	
Any signs of structural failure	<b>No</b>	
Test results	<b>POSITIVE</b>	

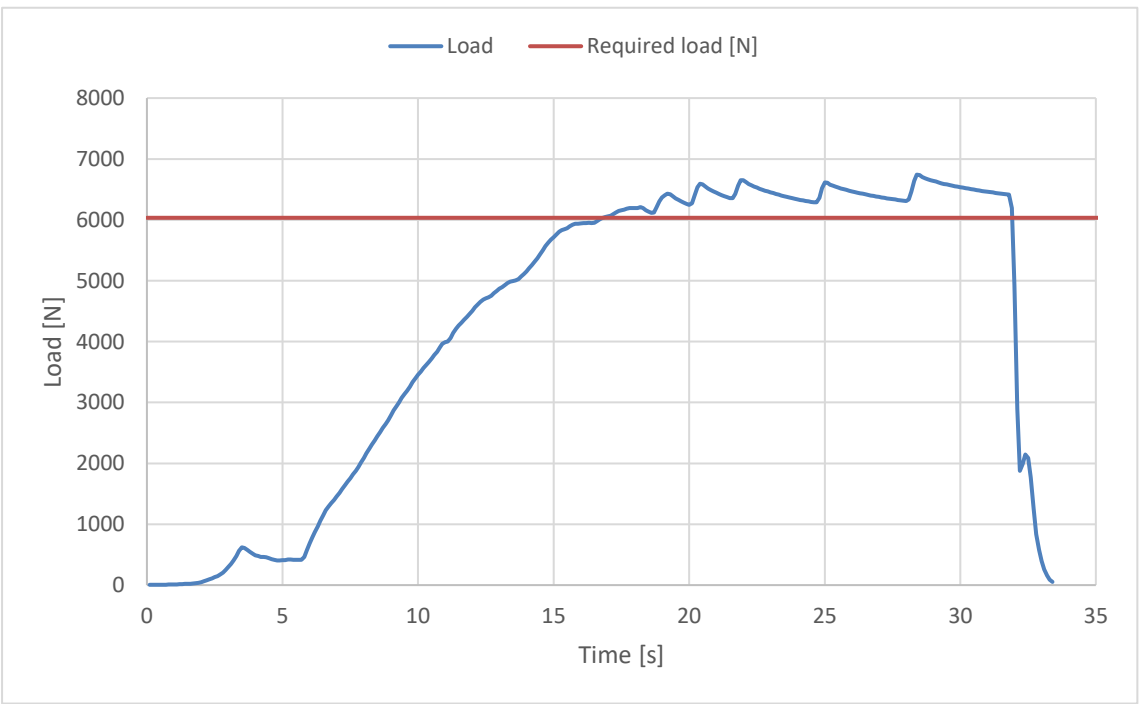

The validation of this test report is given by the signature of the test manager on the Inspection Certificate no 94.20a

Inspection certificate number: **PH\_399.2023**

model: **ARTUS Light 2023**

**Harness Structural test**

**Test ID 07**

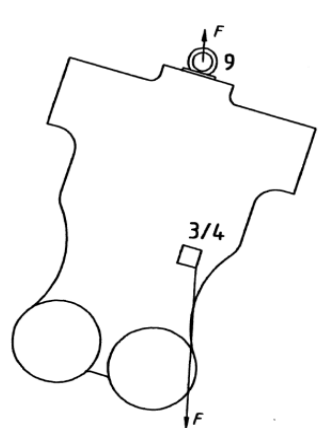
Standard	<b>EN 1651:1999</b>	
Reference	<b>5.3.2.6</b>	
Test setup	<b>Asymmetric, negative</b>	
Attachment points	<b>One main riser attachment (3 or 4) downwards</b>	
Anchor points	<b>Dummy (9)</b>	
Required load [g]	<b>4.5</b>	
Required load [N]	<b>4500</b>	
Minimum test duration [s]	<b>10</b>	
<b>Result</b>		
Test duration [s]	<b>16.5</b>	
Any signs of structural failure	<b>No</b>	
Test results	<b>POSITIVE</b>	

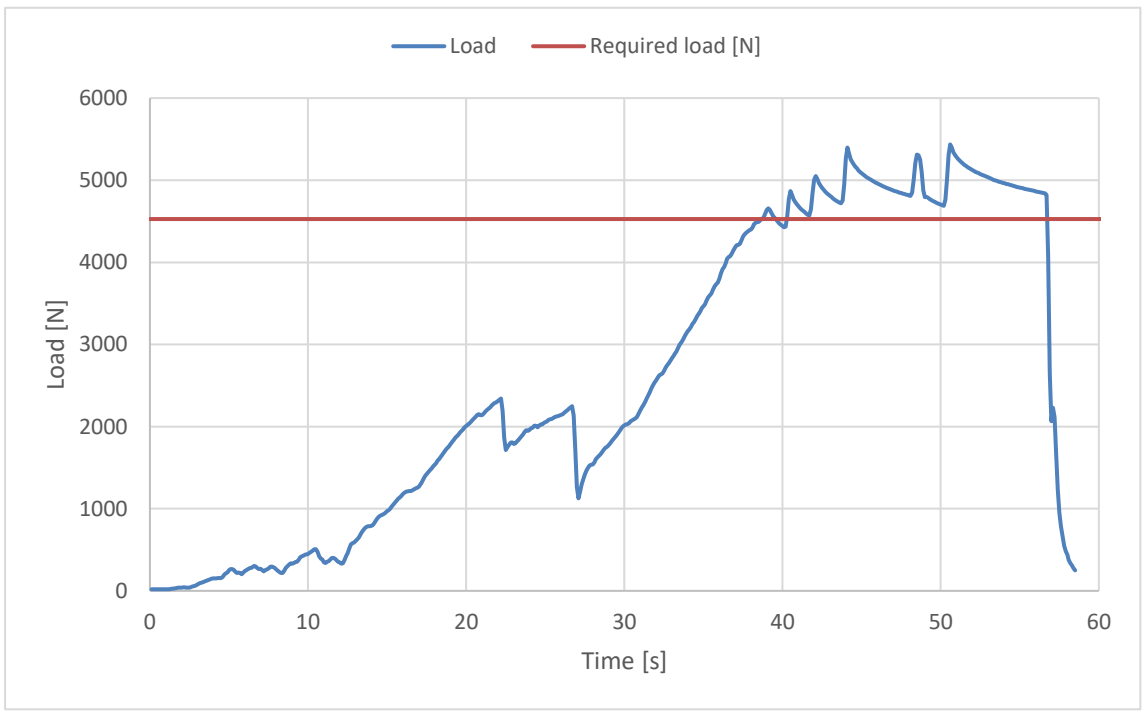

The validation of this test report is given by the signature of the test manager on the Inspection Certificate no 94.20a

Inspection certificate number: **PH\_399.2023**

model: **ARTUS Light 2023**

**Harness Structural test**

**Test ID 13**

Standard	<b>EN 1651:1999</b>
Reference	<b>5.3.2.7</b>
Test setup	<b>Flying position before landing</b>
Attachment points	<b>Both main riser attachment (3,4)</b>
Anchor points	<b>Dummy (7,8)</b>
Required load [g]	<b>15</b>
Required load [N]	<b>15000</b>
Minimum test duration [s]	<b>5</b>
<b>Result</b>	
Test duration [s]	<b>11.1</b>
Any signs of structural failure	<b>No</b>
Test results	<b>POSITIVE</b>

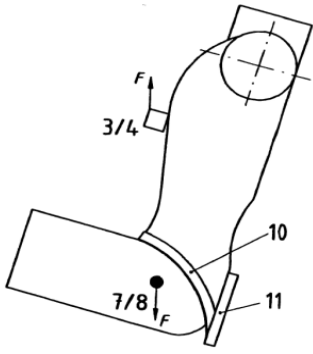
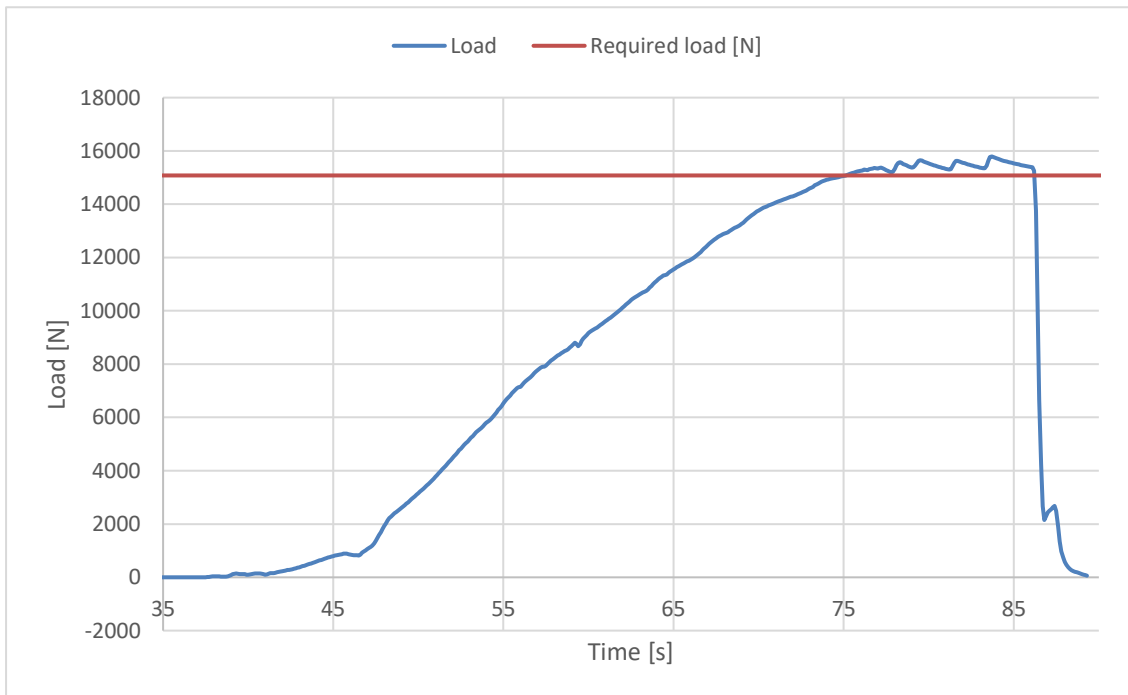
The validation of this test report is given by the signature of the test manager on the Inspection Certificate no 94.20a

Inspection certificate number: **PH\_399.2023**

model: **ARTUS Light 2023**

**Rescue Deployment Test**

**Test ID RRDT**

Standard **NfL 2-565-20**  
 Reference **6.1.5**  
 Test setup **Default flying position**  
 Attachment points **Sensor connect to handle, and pull in opening direction**  
 The test is to simulate the load required to open the emergency parachute(1st action).

Min. Required load [N] **20**  
 Max. Required load [N] **70**

**Result**

Load for first action [N] **46.69**  
 Test results **POSITIVE**

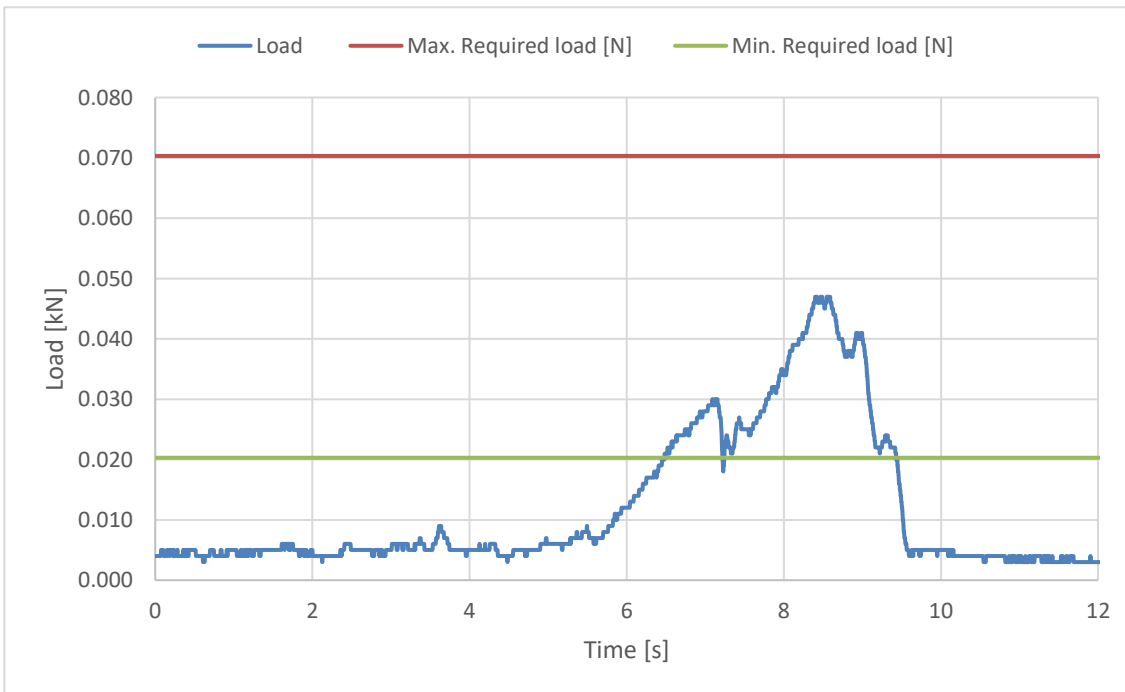

The validation of this test report is given by the signature of the test manager on the Inspection Certificate no 94.20a

Inspection certificate number: **PH\_399.2023**

model: **ARTUS Light 2023**

**Rescue Deployment Handle strength test**

**Test ID RRST**

Standard	<b>EN 12491</b>
Reference in standard	<b>5.3.2</b>
Test setup	<b>Two end points of handle</b>
Attachment points	<b>Sensor connect to end of handle, pull on the other side</b>
	The handle must support min 700 N for 10 s, after measure breaking strength
Min. Required load [N]	<b>700</b>
Minimum test duration [s]	<b>10</b>
<b>Result</b>	
Test duration [s]:	<b>15.1</b>
Breaking strength [N]	<b>2440.68</b>
Test results	<b>POSITIVE</b>

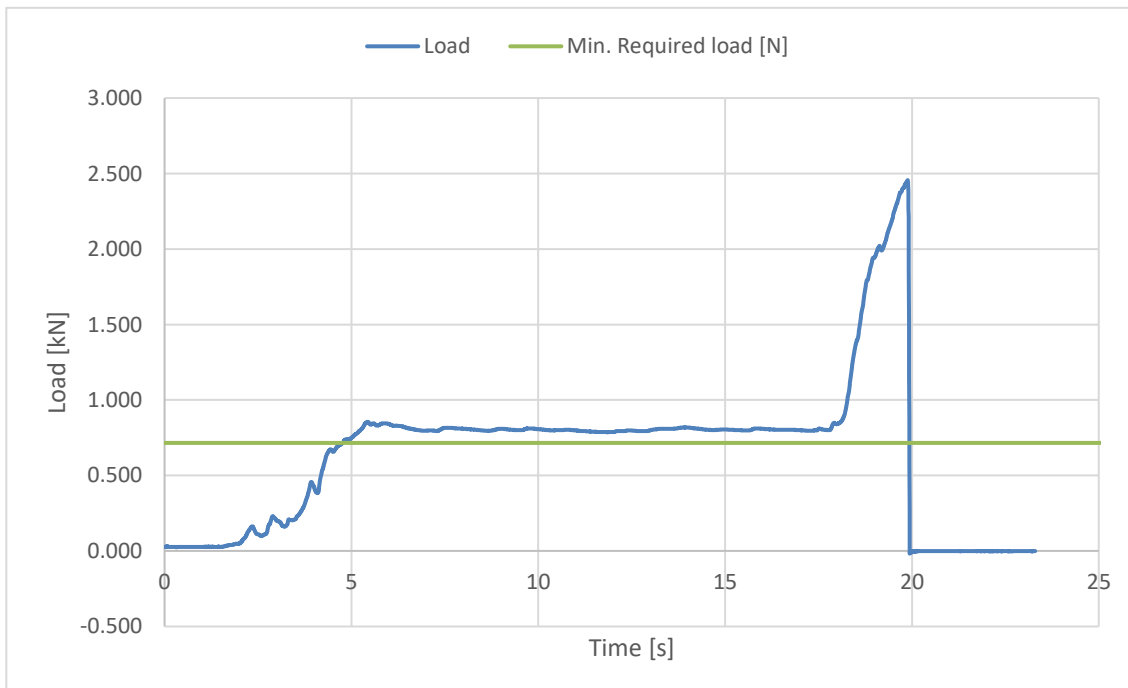

The validation of this test report is given by the signature of the test manager on the Inspection Certificate no 94.20a