

## Harness Structural test Report - EN

Inspection certificate number: **PH\_309.2020**

### Manufacturer data:

Manufacturer name: **OZONE Gliders**  
 Representative: **Russell Ogden**  
 Street: **2, Queens Drive**  
 Post code place: **LA46LN**  
 Country: **UK**

### Sample data:

Name: **Switch**  
 Type: **ABS**  
 Size: **M/L**  
 Serial number: **001**  
 Impact pad type: <sup>(1)</sup> **Inflatable**  
 Clip-in weight [kg]: **120**  
 Date of test: **13.07.2020**

### Atmosphere AGL:

[C°]	<b>22.4</b>
RH [%]	<b>45</b>
[hPa]	<b>975.2</b>

### Summary of Structural test

Test id	- EN 1651	Setup	Req. Load		Min. duration [s]	Result
			[g]	Req. Load [N]		
01 <sup>(3)</sup>	✓ 5.5.1.1	Positive symmetric load (Slippage)	4.5	5400	5	POSITIVE
03 <sup>(3)</sup>	✓ 5.5.1.1b	Positive symmetric load	15	18000	5	POSITIVE
05	✓ 5.5.1.2	Positive asymmetric load	6	7200	5	POSITIVE
06	✓ 5.5.1.6	Negative symmetric load	6	7200	5	POSITIVE
08 <sup>(5)</sup>	5.5.1.9	Anti falling-out system	4.5	5400	5	n/a
09 <sup>(3)(4)</sup>	✓ 5.5.1.3	Positive symmetric load rescue points	15	18000	5	POSITIVE
10 <sup>(3)(4)</sup>	5.5.1.4	Negative symmetric load rescue points	15	18000	5	n/a
11	5.5.1.8	Connecting element for rescue	n/a	24000	0.3	n/a
12 <sup>(3)</sup>	✓ 5.5.1.7	Upright (landing) position load	6	7200	5	POSITIVE
14	5.5.1.5	Negative symmetric load towing points	5	6000	5	n/a

### Rescue deployment test

Test id	- NfL II 91/09	Setup	Min load		Measured [N]	Result
			[N]	Max. load [N]		
RRDT	✓ 6.1.5	Default flying position	20	70	44.73	POSITIVE

### Rescue Deployment Handle strength test

Test id	- EN 12491	Setup	Req. Load [N]	Min. duration [s]	Breaking strength [N]	Result
RRST	✓ 5.3.2	Two end points of handle	700	10	1040.71	POSITIVE

Manufacture	Instrument	Type no	S/N	Validity Calibration
HBM	Load Sensor GE01	1-S9M/50KN-	31314643	04.09.2023
Burster	Sensor Burster	8431-10000	1185483	04.09.2023
JDC elec	Geos n°11 Skywatch	Geos n°11	22	08.05.2020

Air Turquoise SA, having thoroughly assessed the sample mentioned above, declare it was found conform with  
 European Standard **EN1651:2018**, and **EN12491:2015**

The validation of this test report is given by the signature of the test manager on the Inspection Certificate no 94.20

(1) If Impact pad available, see test report no. 94.22 and inspection certificate no. 94.20. <sup>(3)</sup> Slipping test of any adjustable components: No slippage of any adjustable element more than 10 mm at 4500N for 5 s. The marks should be added with a pre-load of 1000N. <sup>(4)</sup> For harness with integrated Y bridle, test in the end loop <sup>(5)</sup> Attach to anti-falling out system without connecting the crotch straps (breast straps)

Calculated value in tests reports include the value minus the uncertainty (on safe side) / The uncertainty stated is the expanded uncertainty obtained by multiplying the standard uncertainty by the coverage factor k = 2. The value of the measurand lies within the assigned range of values with a probability of 95%.

This declaration must not be reproduced in part without the written permission of AIR TURQUOISE SA.

Inspection certificate number: **PH\_309.2020**

model: **Switch**

**Harness Structural test**

**Test ID 01**

Standard	<b>EN 1651</b>
Reference in standard	<b>5.5.1.1</b>
Test setup	<b>Positive symmetric load (Slippage)</b>
Attachment points	<b>Both main riser attachment (3,4)</b>
Anchor points	<b>Dummy (B1, B2)</b>
Required load [g]	<b>4.5</b>
Required load [N]	<b>5400</b>
Minimum test duration [s]	<b>5</b>
<b>Result</b>	
Test duration [s]	<b>21.4</b>
Any signs of structural failure	<b>No</b>
Slippery test OK	<b>Yes</b>
Test results	<b>POSITIVE</b>

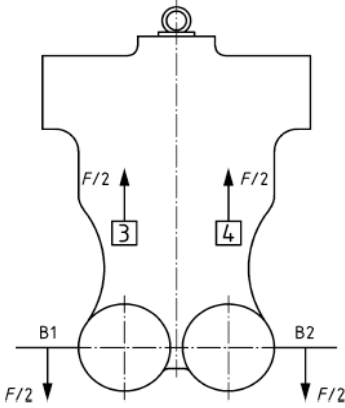
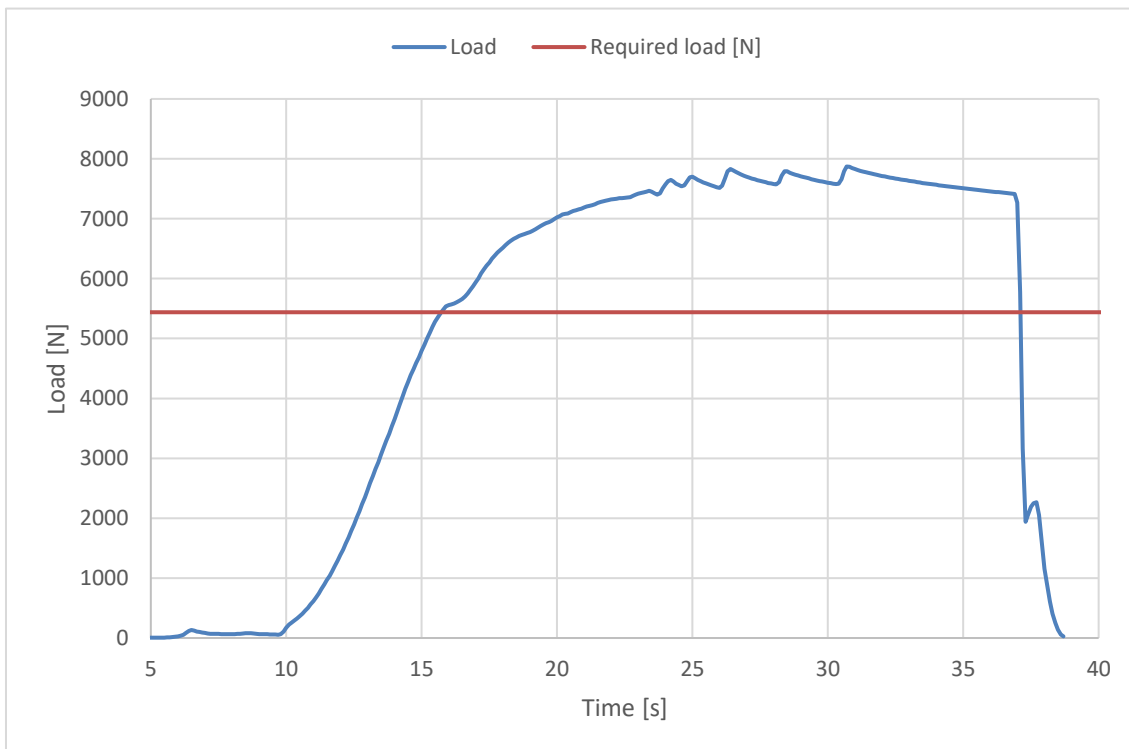
The validation of this test report is given by the signature of the test manager on the Inspection Certificate no 94.20

Inspection certificate number: **PH\_309.2020**

model: **Switch**

**Harness Structural test**

**Test ID 03**

Standard **EN 1651**  
 Reference in standard **5.5.1.1b**  
 Test setup **Positive symmetric load**  
 Attachment points **Both main riser attachment (3,4)**  
 Anchor points **Dummy (B1, B2)**

Required load [g] **15**  
 Required load [N] **18000**  
 Minimum test duration [s] **5**

**Result**

Test duration [s] **8**  
 Any signs of structural failure **No**  
 Slippery test OK **Yes**  
 Test results **POSITIVE**

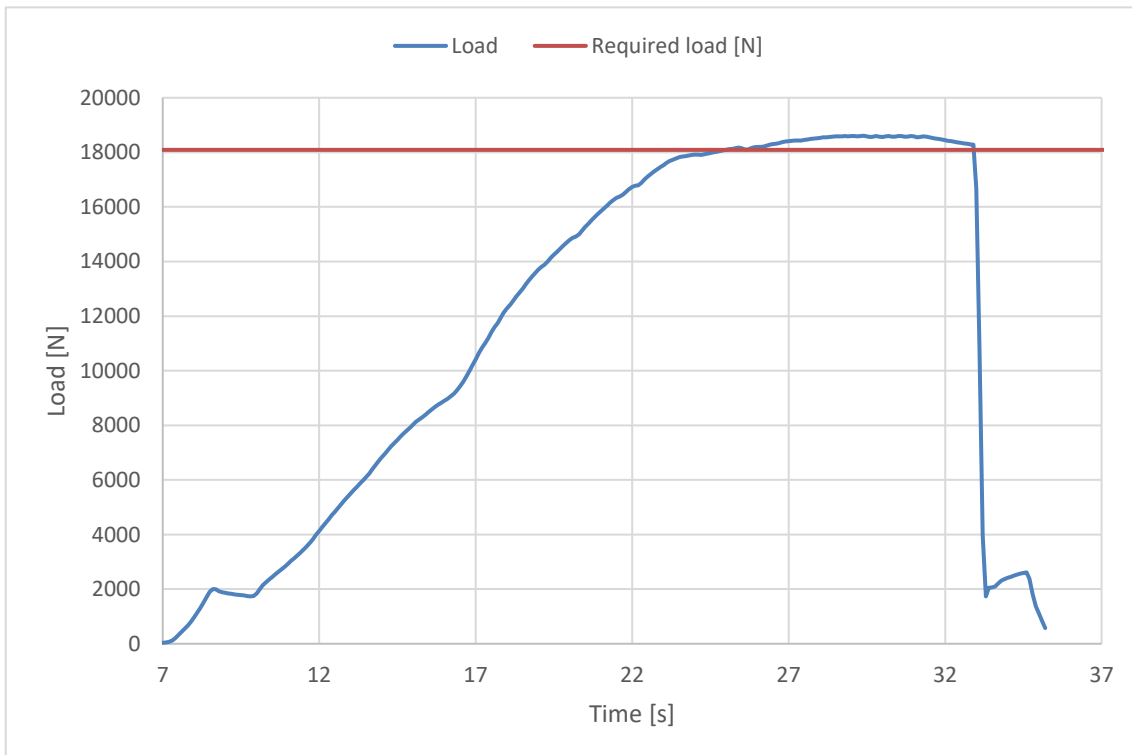
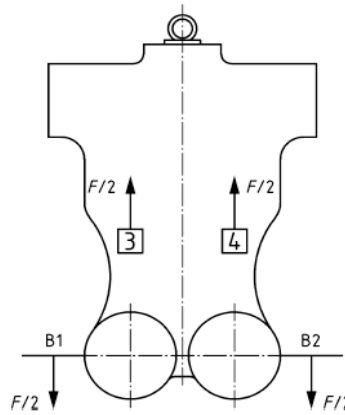

The validation of this test report is given by the signature of the test manager on the Inspection Certificate no 94.20

Inspection certificate number: **PH\_309.2020**

model: **Switch**

**Harness Structural test**

**Test ID 05**

Standard	<b>EN 1651</b>
Reference in standard	<b>5.5.1.2</b>
Test setup	<b>Positive asymmetric load</b>
Attachment points	<b>One riser attachment (3 or 4)</b>
Anchor points	<b>Dummy (C)</b>
Required load [g]	<b>6</b>
Required load [N]	<b>7200</b>
Minimum test duration [s]	<b>5</b>
<b>Result</b>	
Test duration [s]	<b>16.7</b>
Any signs of structural failure	<b>No</b>
Test results	<b>POSITIVE</b>

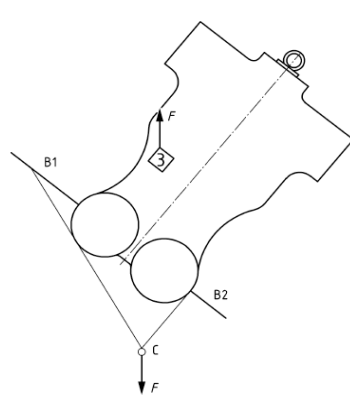
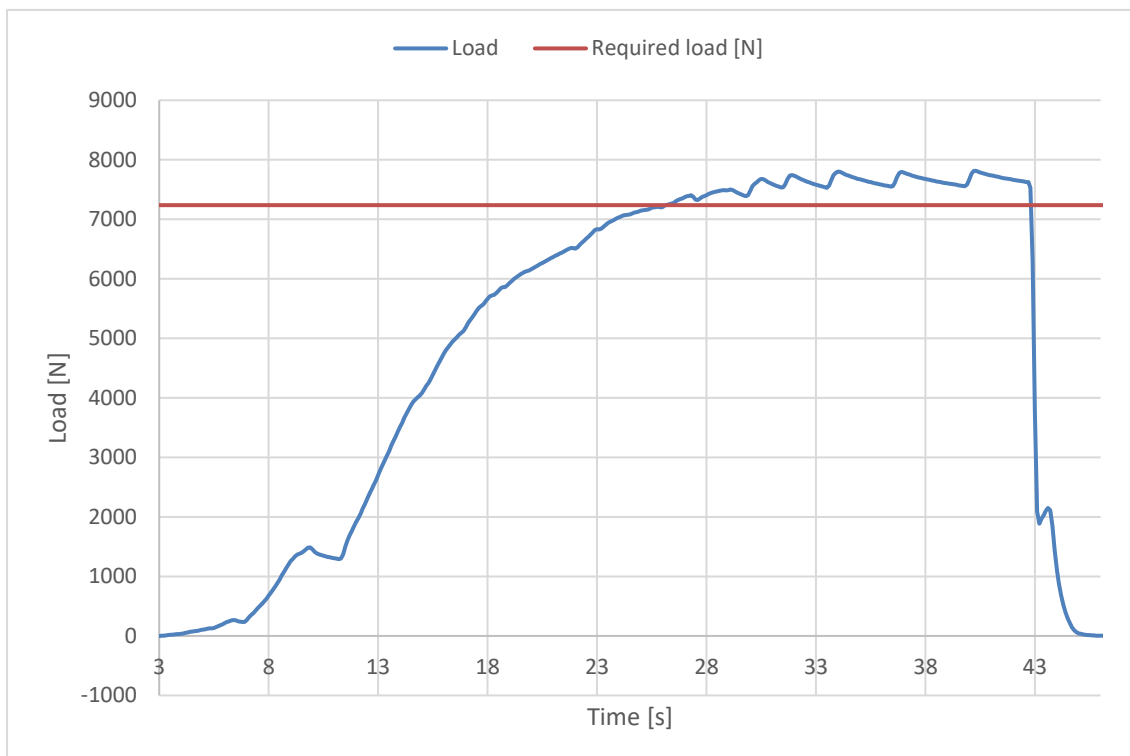
The validation of this test report is given by the signature of the test manager on the Inspection Certificate no 94.20

Inspection certificate number: **PH\_309.2020**

model: **Switch**

**Harness Structural test**

**Test ID 06**

Standard	<b>EN 1651</b>
Reference in standard	<b>5.5.1.6</b>
Test setup	<b>Negative symmetric load</b>
Attachment points	<b>Both main riser attachment (3,4)</b>
Anchor points	<b>Dummy (A)</b>
Required load [g]	<b>6</b>
Required load [N]	<b>7200</b>
Minimum test duration [s]	<b>5</b>
<b>Result</b>	
Test duration [s]	<b>9.9</b>
Any signs of structural failure	<b>No</b>
Test results	<b>POSITIVE</b>

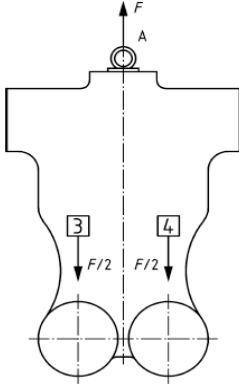
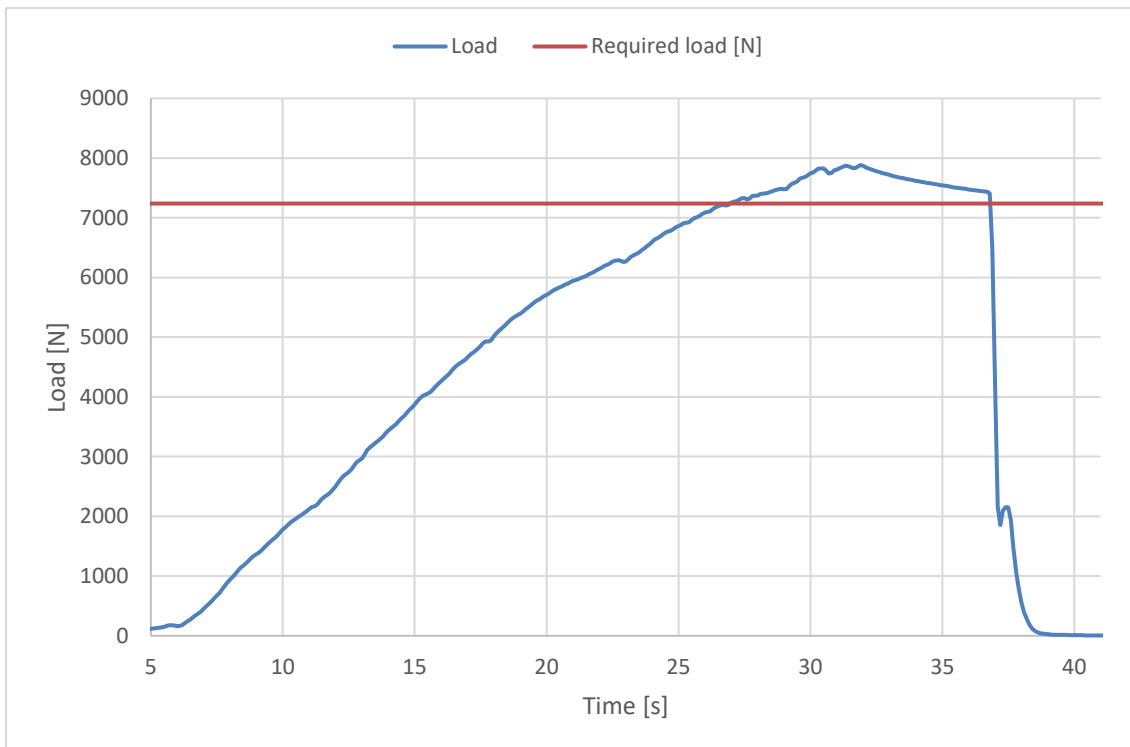
The validation of this test report is given by the signature of the test manager on the Inspection Certificate no 94.20

Inspection certificate number: **PH\_309.2020**

model: **Switch**

**Harness Structural test**

**Test ID 09**

Standard **EN 1651**  
 Reference in standard **5.5.1.3**  
 Test setup **Positive symmetric load rescue points**  
 Attachment points **Both main riser attachment (1,2)**  
 Anchor points **Dummy (B1,B2)**

Required load [g] **15**  
 Required load [N] **18000**  
 Minimum test duration [s] **5**

**Result**

Test duration [s] **6.7**  
 Any signs of structural failure **No**  
 Slippery test OK **Yes**  
 Test results **POSITIVE**

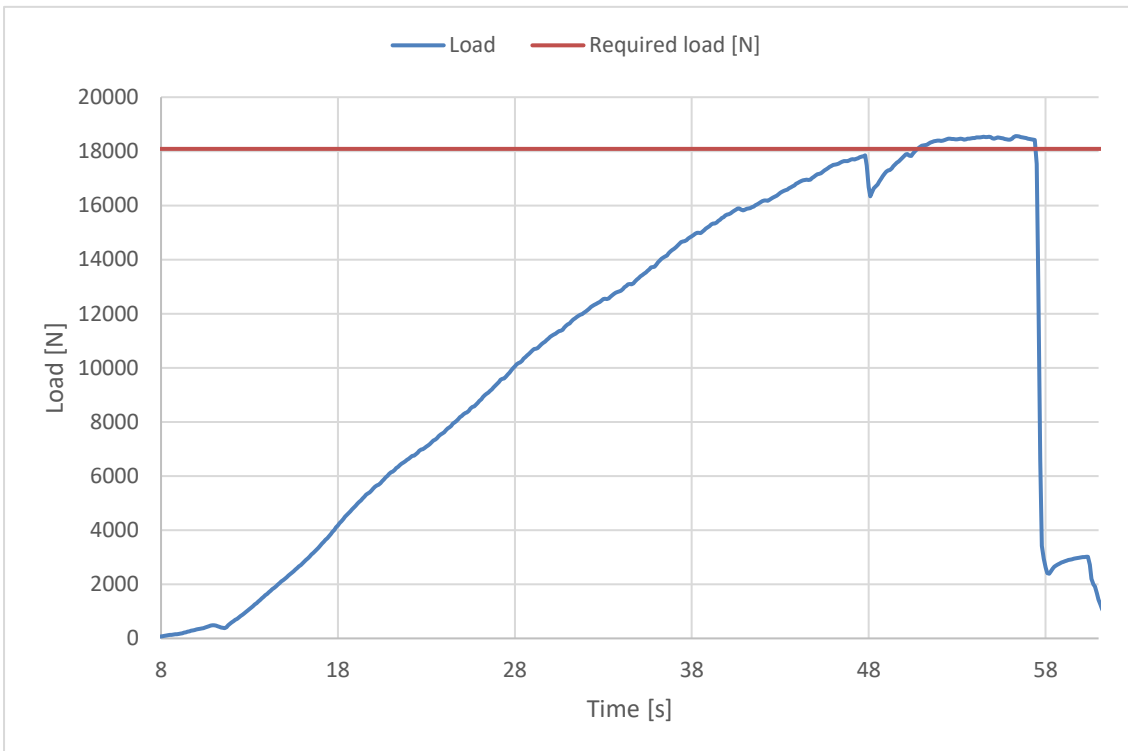
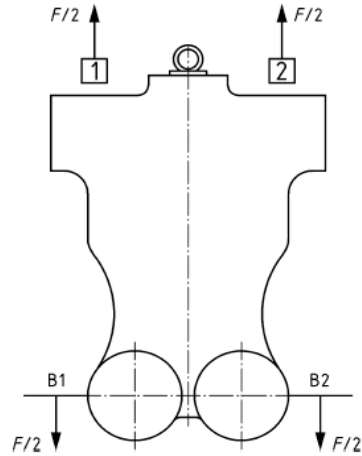

The validation of this test report is given by the signature of the test manager on the Inspection Certificate no 94.20

Inspection certificate number: **PH\_309.2020**

model: **Switch**

**Harness Structural test**

**Test ID 12**

Standard	<b>EN 1651</b>
Reference in standard	<b>5.5.1.7</b>
Test setup	<b>Upright (landing) position load</b>
Attachment points	<b>Both main riser attachment (3, 4)</b>
Anchor points	<b>Both legstrap of harness (no dummy)</b>
Required load [g]	<b>6</b>
Required load [N]	<b>7200</b>
Minimum test duration [s]	<b>5</b>
Harness type	<b>type c</b>
<b>Result</b>	
Test duration [s]	<b>7.8</b>
Any signs of structural failure	<b>No</b>
Slippery test OK	<b>Yes</b>
Test results	<b>POSITIVE</b>

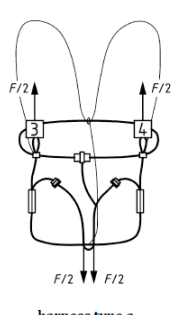
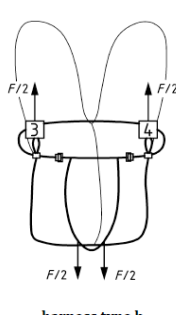
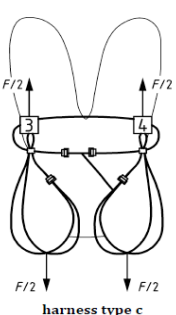

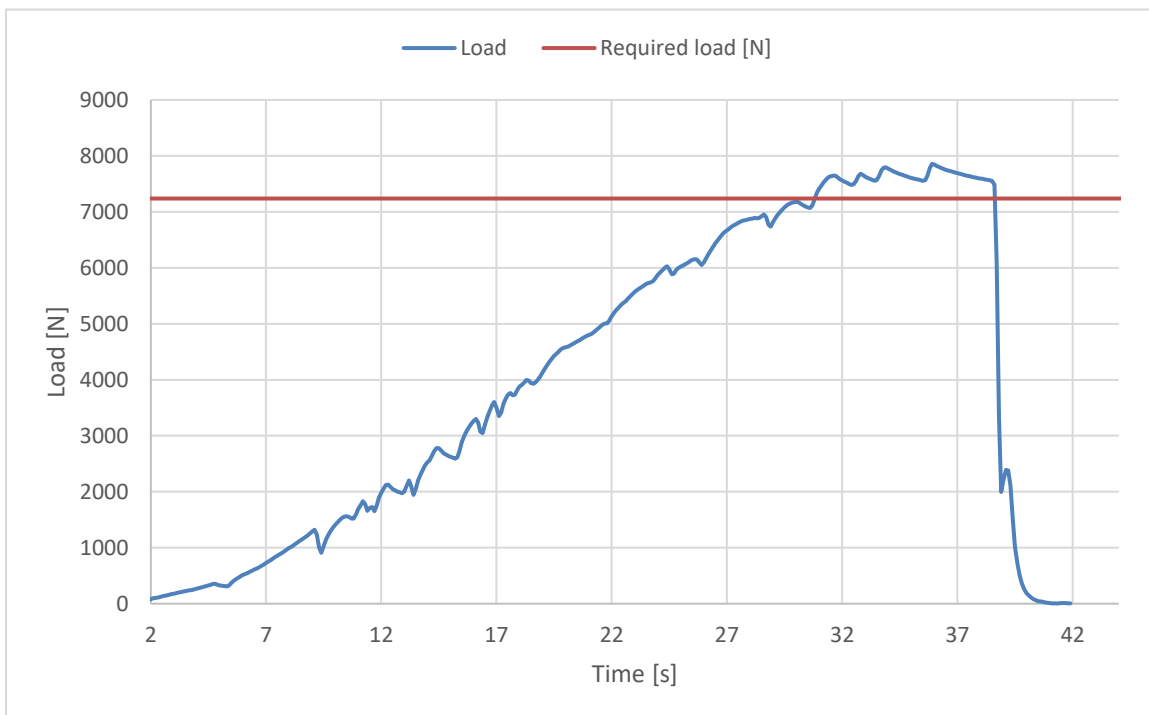
The validation of this test report is given by the signature of the test manager on the Inspection Certificate no 94.20

Inspection certificate number: **PH\_309.2020**

model: **Switch**

**Rescue Deployment Test**

**Test ID RRDT**

Standard	<b>LTF NfL II 91/09</b>
Reference in standard	<b>6.1.5</b>
Test setup	<b>Default flying position</b>
Attachment points	<b>Sensor connect to handle, and pull in opening direction</b>
	The test is to simulate the load required to open the emergency parachute(1st action).
Min. Required load [N]	<b>20</b>
Max. Required load [N]	<b>70</b>
<b>Result</b>	
Load for first action [N]	<b>44.73</b>
Test results	<b>POSITIVE</b>

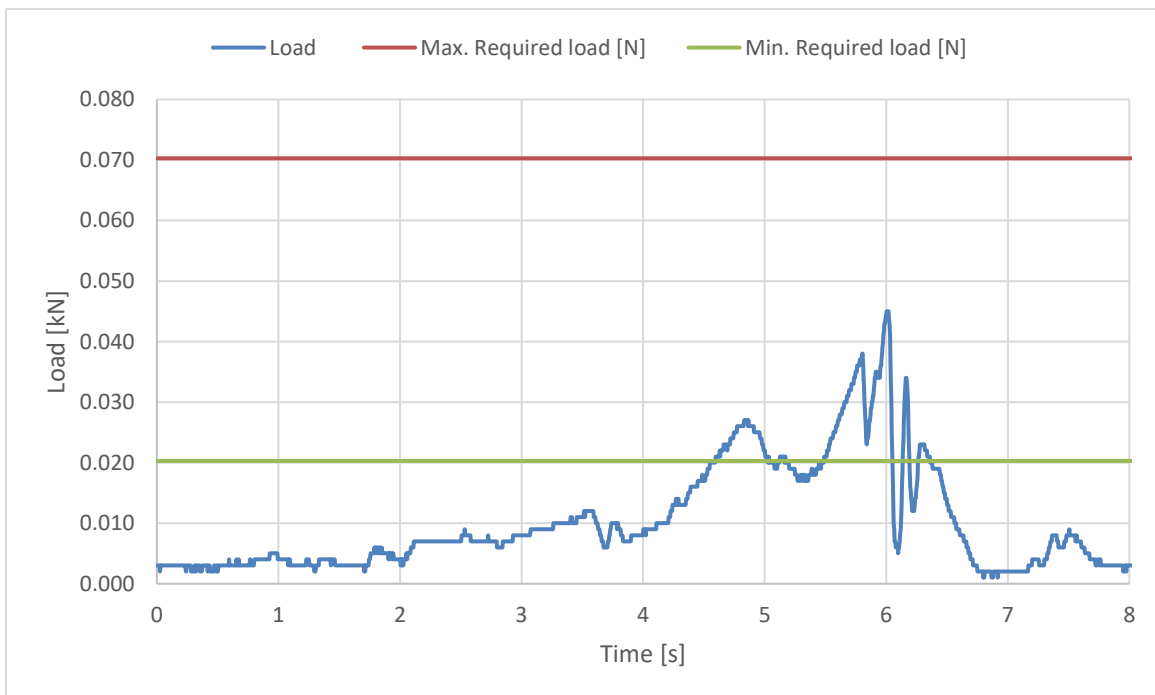

The validation of this test report is given by the signature of the test manager on the Inspection Certificate no 94.20



Inspection certificate number: **PH\_309.2020**

model: **Switch**

**Rescue Deployment Handle strength test**

**Test ID RRST**

Standard	<b>EN12491:2015</b>
Reference in standard	<b>5.3.2</b>
Test setup	<b>Two end points of handle</b>
Attachment points	<b>Sensor connect to end of handle, pull on the other side</b>
	The handle must support min 700 N for 10 s, after measure breaking strength
Min. Required load [N]	<b>700</b>
Minimum test duration [s]	<b>10</b>
<b>Result</b>	
Test duration [s]:	<b>14.0</b>
Breaking strength [N]	<b>1040.71</b>
Test results	<b>POSITIVE</b>

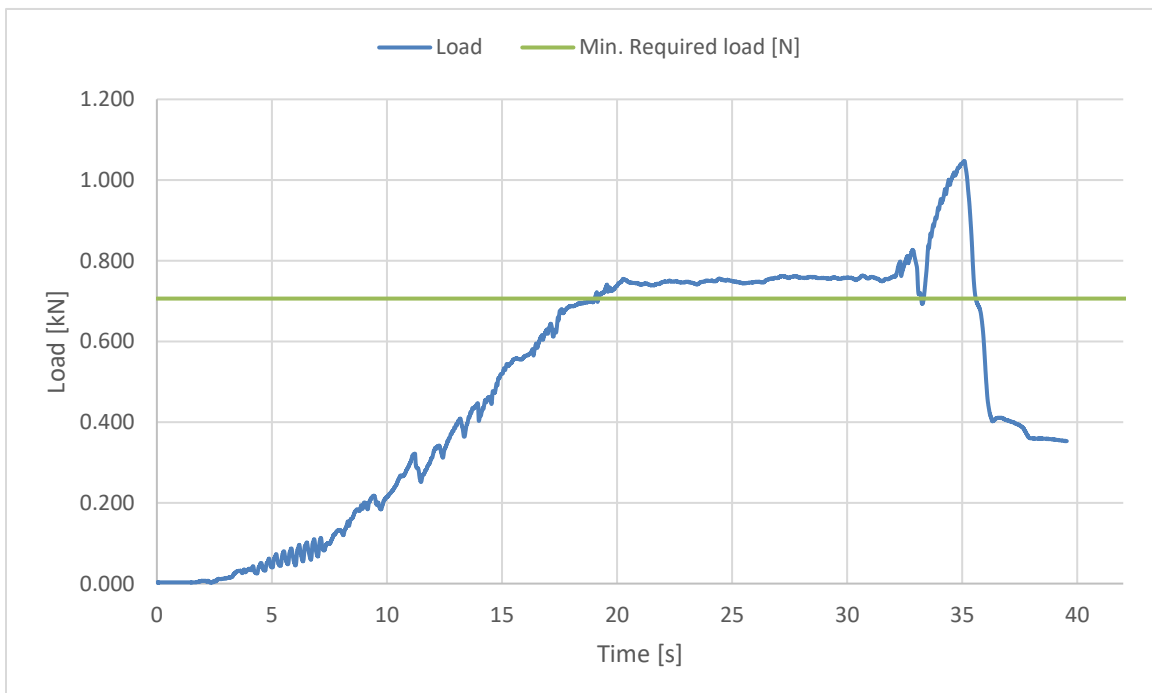

The validation of this test report is given by the signature of the test manager on the Inspection Certificate no 94.20