

Harness Structural test Report - EN

Inspection certificate number: **PH_293.2020**

Manufacturer data:

Manufacturer name: **Neo SAS**
 Representative: **Eric Roussel**
 Street: **ZA des Vernays**
 Post code place: **74210 Doussard**
 Country: **France**

Sample data:

Name: **Bikini**
 Type: **ABS**
 Size: **SM**
 Serial number: **H12002**
 Impact pad type: ⁽¹⁾ **Koroyd**
 Clip-in weight [kg]: **120**
 Date of test: **07.02.2020**

Atmosphere AGL:

[C°]	21.7
RH [%]	32
[hPa]	982.5

Summary of Structural test

Test id	- EN 1651:2018	Setup	Req. Load		Min. duration [s]	Result
			[g]	Req. Load [N]		
01 ⁽³⁾	V 5.5.1.1	Positive symmetric load (Slippage)	4.5	5400	5	POSITIVE
03 ⁽³⁾	V 5.5.1.1b	Positive symmetric load	15	18000	5	POSITIVE
05	V 5.5.1.2	Positive asymmetric load	6	7200	5	POSITIVE
06	V 5.5.1.6	Negative symmetric load	6	7200	5	POSITIVE
08 ⁽⁵⁾	5.5.1.9	Anti falling-out system	4.5	5400	5	n/a
09 ⁽³⁾⁽⁴⁾	5.5.1.3	Positive symmetric load rescue points	15	18000	5	n/a
10 ⁽³⁾⁽⁴⁾	5.5.1.4	Negative symmetric load rescue points	15	18000	5	n/a
11	5.5.1.8	Connecting element for rescue	n/a	24000	0.3	n/a
12 ⁽³⁾	V 5.5.1.7	Upright (landing) position load	6	7200	5	POSITIVE
14	5.5.1.5	Negative symmetric load towing points	5	6000	5	n/a

Rescue deployment test

Test id	- NfL II 91/09	Setup	Min load			Result
			[N]	Max. load [N]	Measured [N]	
RRDT	V 6.1.5	Default flying position	20	70	52.68	POSITIVE

Rescue Deployment Handle strength test

Test id	- EN 12491	Setup	Req. Load [N]	Min. duration [s]	Breaking strength [N]	Result
RRST	V 5.3.2	Two end points of handle	700	10	1179.87	POSITIVE

Manufacture	Instrument	Type no	S/N	Validity Calibration
HBM	Load Sensor GE01	1-S9M/50KN-	31314643	04.09.2023
Burster	Sensor Burster	8431-10000	1185483	04.09.2023
JDC elec	Geos n°11 Skywatch	Geos n°11	22	08.05.2020

Air Turquoise SA, having thoroughly assessed the sample mentioned above, declare it was found conform with

European Standard EN1651:2018, and EN12491:2015

The validation of this test report is given by the signature of the test manager on the Inspection Certificate no 94.20

(1) If Impact pad available, see test report no. 94.22 and inspection certificate no. 94.20. ⁽³⁾ Slipping test of any adjustable components: No slippage of any adjustable element more than 10 mm at 4500N for 5 s. The marks should be added with a pre-load of 1000N. ⁽⁴⁾ For harness with integrated Y bridle, test in the end loop ⁽⁵⁾ Attach to anti-falling out system without connecting the crotch straps (breast straps)

uncertainty by the coverage factor k = 2. The value of the measurand lies within the assigned range of values with a probability of 95%.

This declaration must not be reproduced in part without the written permission of AIR TURQUOISE SA.

Inspection certificate number: **PH_293.2020**

model: **Bikini**

Harness Structural test

Test ID 01

Standard **EN 1651:2018**
 Reference in standard **5.5.1.1**
 Test setup **Positive symmetric load (Slippage)**
 Attachment points **Both main riser attachment (3,4)**
 Anchor points **Dummy (B1, B2)**

Required load [g] **4.5**
 Required load [N] **5400**
 Minimum test duration [s] **5**

Result

Test duration [s] **9.3**
 Any signs of structural failure **No**
 Slippery test OK **No**
 Test results **POSITIVE**

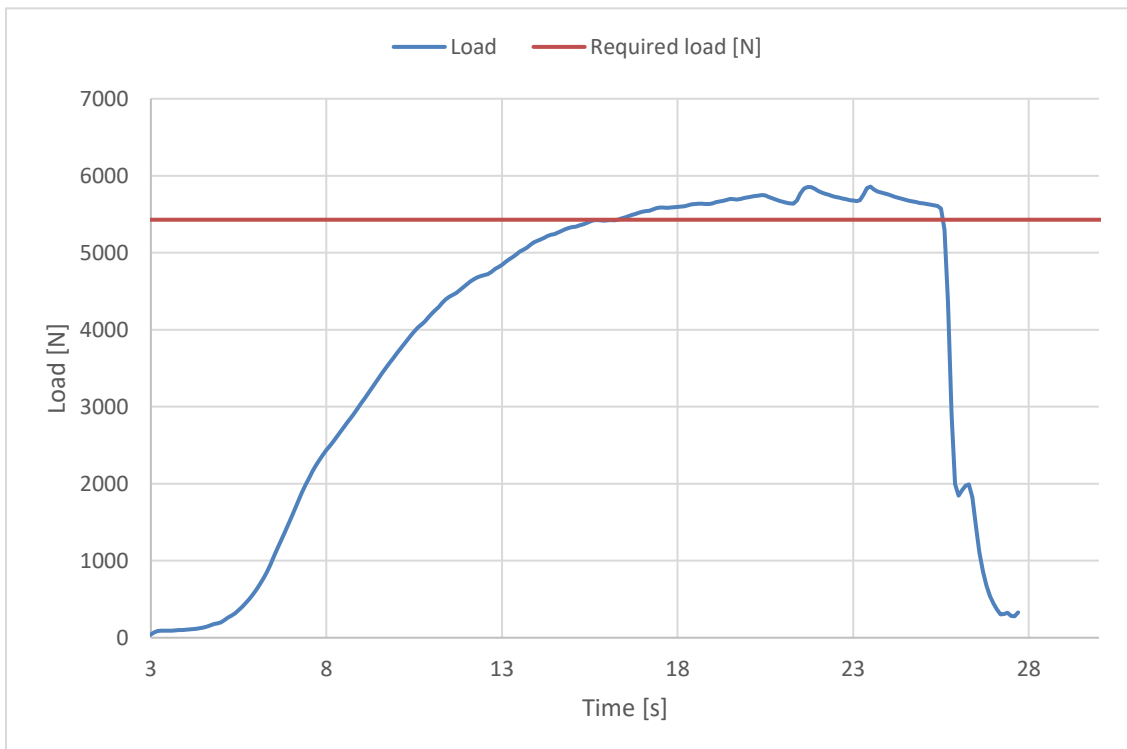
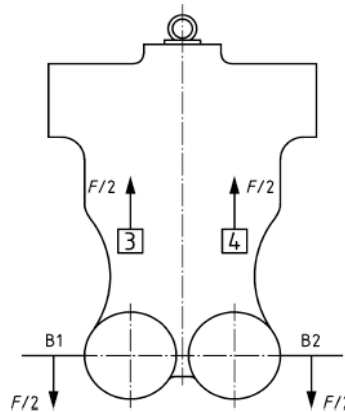

The validation of this test report is given by the signature of the test manager on the Inspection Certificate no 94.20

Inspection certificate number: **PH_293.2020**

model: **Bikini**

Harness Structural test

Test ID 03

Standard **EN 1651:2018**
 Reference in standard **5.5.1.1b**
 Test setup **Positive symmetric load**
 Attachment points **Both main riser attachment (3,4)**
 Anchor points **Dummy (B1, B2)**

Required load [g] **15**
 Required load [N] **18000**
 Minimum test duration [s] **5**

Result

Test duration [s] **7.8**
 Any signs of structural failure **No**
 Slippery test OK **No**
 Test results **POSITIVE**

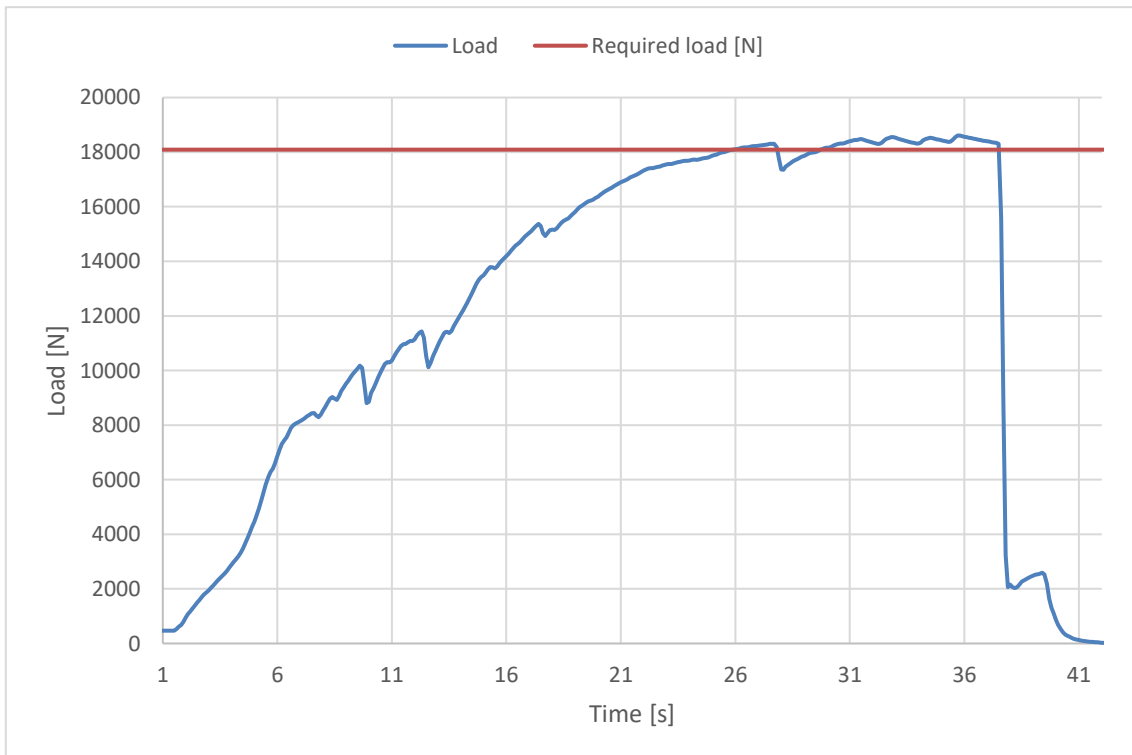
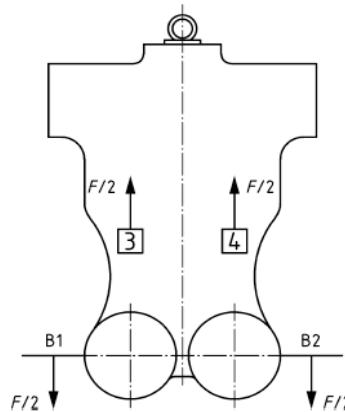

The validation of this test report is given by the signature of the test manager on the Inspection Certificate no 94.20

Inspection certificate number: **PH_293.2020**

model: **Bikini**

Harness Structural test

Test ID 05

Standard	EN 1651:2018
Reference in standard	5.5.1.2
Test setup	Positive asymmetric load
Attachment points	One riser attachment (3 or 4)
Anchor points	Dummy (C)
Required load [g]	6
Required load [N]	7200
Minimum test duration [s]	5
Result	
Test duration [s]	8.5
Any signs of structural failure	No
Test results	POSITIVE

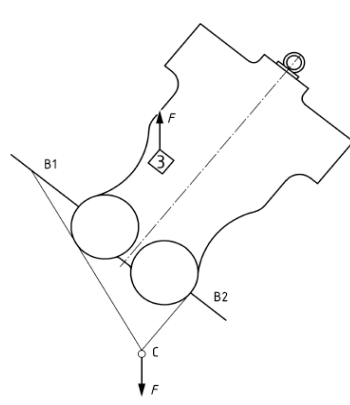
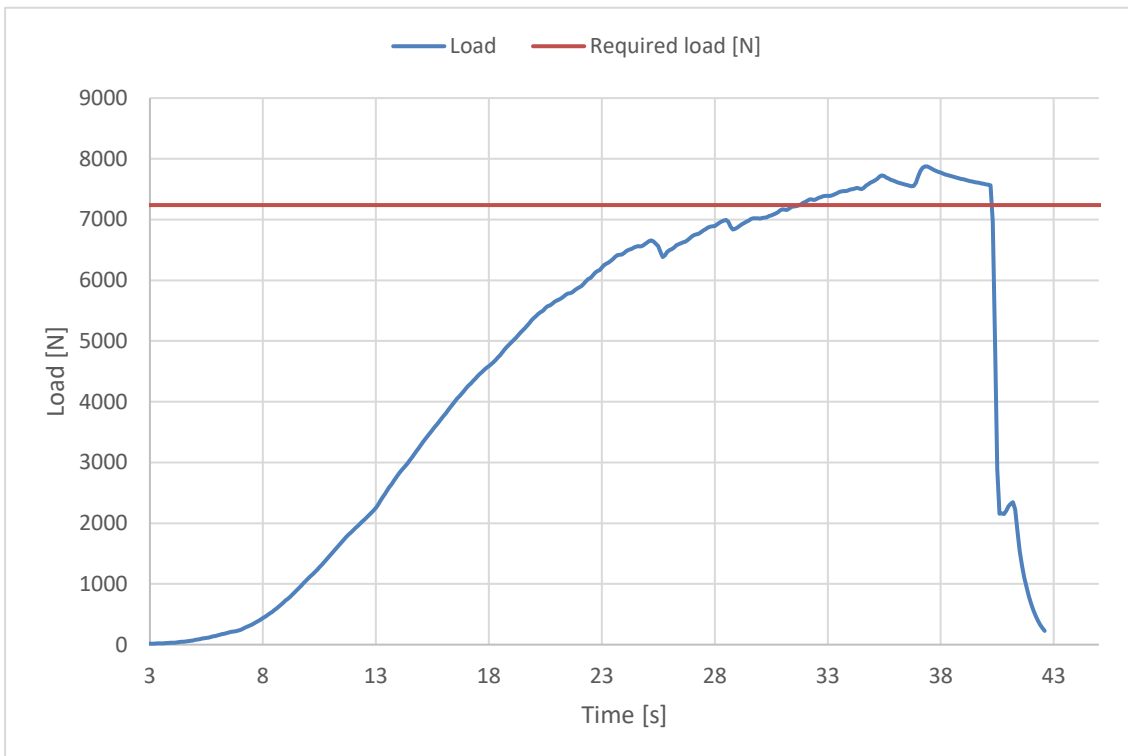
The validation of this test report is given by the signature of the test manager on the Inspection Certificate no 94.20

Inspection certificate number: **PH_293.2020**

model: **Bikini**

Harness Structural test

Test ID 06

Standard	EN 1651:2018
Reference in standard	5.5.1.6
Test setup	Negative symmetric load
Attachment points	Both main riser attachment (3,4)
Anchor points	Dummy (A)
Required load [g]	6
Required load [N]	7200
Minimum test duration [s]	5
Result	
Test duration [s]	8.2
Any signs of structural failure	No
Test results	POSITIVE

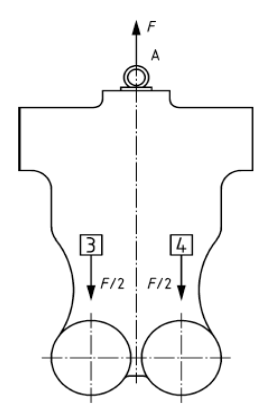
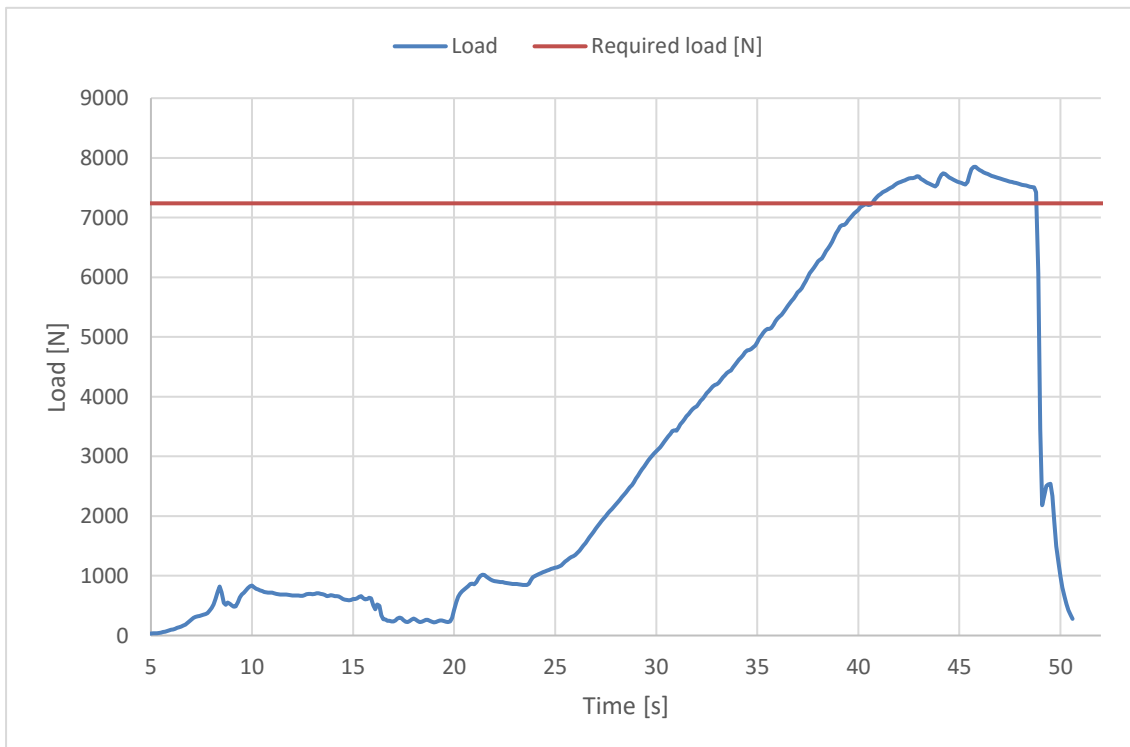
The validation of this test report is given by the signature of the test manager on the Inspection Certificate no 94.20

Inspection certificate number: **PH_293.2020**

model: **Bikini**

Harness Structural test

Test ID 12

Standard	EN 1651:2018
Reference in standard	5.5.1.7
Test setup	Upright (landing) position load
Attachment points	Both main riser attachment (3, 4)
Anchor points	Both legstrap of harness (no dummy)
Required load [g]	6
Required load [N]	7200
Minimum test duration [s]	5
Harness type	type a
Result	
Test duration [s]	7.7
Any signs of structural failure	No
Slippery test OK	No
Test results	POSITIVE

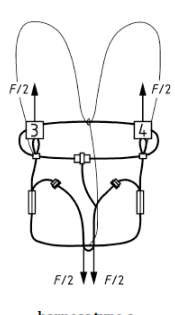
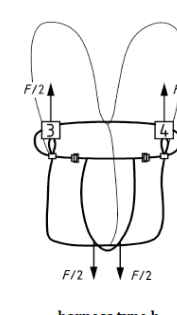
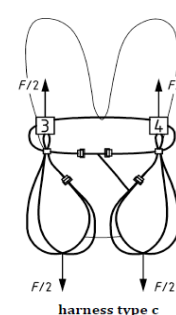

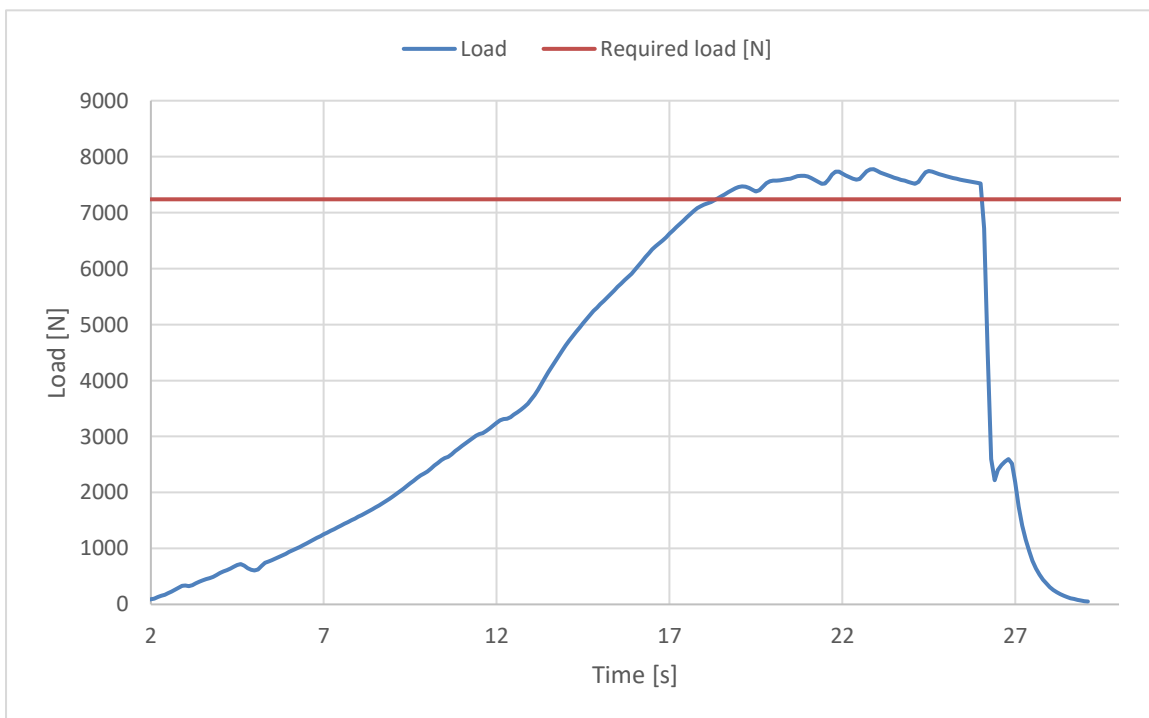
The validation of this test report is given by the signature of the test manager on the Inspection Certificate no 94.20

Inspection certificate number: **PH_293.2020**

model: **Bikini**

Rescue Deployment Test

Test ID RRDT

Standard	LTF NfL II 91/09
Reference in standard	6.1.5
Test setup	Default flying position
Attachment points	Sensor connect to handle, and pull in opening direction
	The test is to simulate the load required to open the emergency parachute(1st action).
Min. Required load [N]	20
Max. Required load [N]	70
Result	
Load for first action [N]	52.68
Test results	POSITIVE

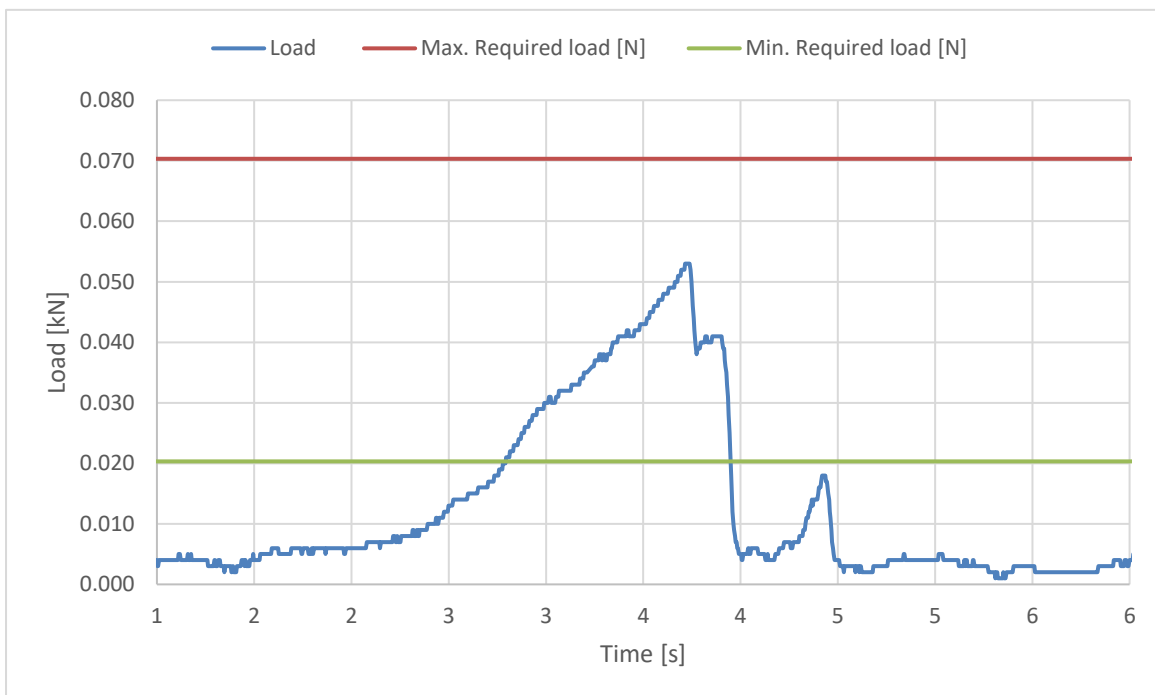

The validation of this test report is given by the signature of the test manager on the Inspection Certificate no 94.20

Inspection certificate number: **PH_293.2020**

model: **Bikini**

Rescue Deployment Handle strength test

Test ID RRST

Standard	EN12491:2015
Reference in standard	5.3.2
Test setup	Two end points of handle
Attachment points	Sensor connect to end of handle, pull on the other side
	The handle must support min 700 N for 10 s, after measure breaking strength
Min. Required load [N]	700
Minimum test duration [s]	10
Result	
Test duration [s]:	14.7
Breaking strength [N]	1179.87
Test results	POSITIVE

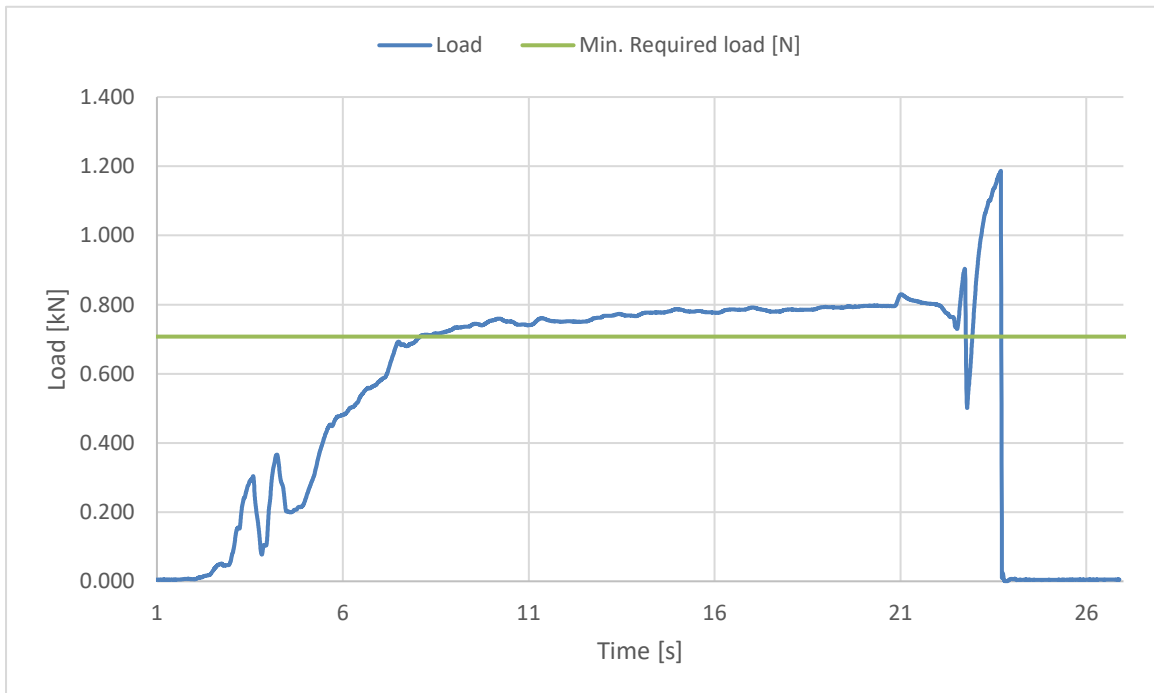

The validation of this test report is given by the signature of the test manager on the Inspection Certificate no 94.20